



**CELESTRON**



**NexStar<sup>TM</sup> 8**

**INSTRUCTION MANUAL**

<b>INTRODUCTION .....</b>	<b>4</b>
WARNING.....	4
<b>QUICK SETUP .....</b>	<b>5</b>
<b>ASSEMBLING THE NEXSTAR .....</b>	<b>8</b>
<i>Powering the NexStar .....</i>	<i>8</i>
<i>Attaching the NexStar to the Tripod.....</i>	<i>9</i>
<i>The Hand Control .....</i>	<i>9</i>
<i>The Star Diagonal.....</i>	<i>10</i>
<i>The Eyepiece .....</i>	<i>10</i>
<i>The Star Pointer Finderscope .....</i>	<i>11</i>
<b>HAND CONTROL .....</b>	<b>13</b>
<i>Hand Control Operation .....</i>	<i>14</i>
<i>Alignment Procedure .....</i>	<i>14</i>
<i>Object Catalog .....</i>	<i>16</i>
<i>Selecting an Object .....</i>	<i>16</i>
<i>Slewing to an Object .....</i>	<i>17</i>
<i>Finding Planets .....</i>	<i>17</i>
<i>Tour Mode.....</i>	<i>17</i>
<i>Direction Buttons .....</i>	<i>18</i>
<i>Rate Button.....</i>	<i>18</i>
<i>Setup Procedures .....</i>	<i>18</i>
<i>Tracking Mode .....</i>	<i>18</i>
<i>Tracking Rate .....</i>	<i>19</i>
<i>Date/Time.....</i>	<i>19</i>
<i>User Defined Objects .....</i>	<i>19</i>
<i>Get RA/DEC.....</i>	<i>19</i>
<i>Get Alt-Az.....</i>	<i>19</i>
<i>Goto R.A/Dec .....</i>	<i>20</i>
<i>Goto Alt-Az.....</i>	<i>20</i>
<i>Utility Features .....</i>	<i>20</i>
<i>Demo .....</i>	<i>20</i>
<i>RS-232.....</i>	<i>20</i>
<i>Light Control.....</i>	<i>20</i>
<i>Cord Wrap.....</i>	<i>20</i>
<i>Anti-backlash .....</i>	<i>20</i>
<b>TELESCOPE BASICS .....</b>	<b>22</b>
<i>Image Orientation.....</i>	<i>22</i>
<i>Focusing.....</i>	<i>23</i>
<i>Calculating Magnification .....</i>	<i>23</i>
<i>Determining Field of View .....</i>	<i>23</i>
<i>General Observing Hints .....</i>	<i>24</i>
<b>ASTRONOMY BASICS.....</b>	<b>25</b>
<i>The Celestial Coordinate System .....</i>	<i>25</i>
<i>Motion of the Stars.....</i>	<i>26</i>
<i>Polar Alignment (with optional Wedge).....</i>	<i>27</i>
<i>Finding the North Celestial Pole .....</i>	<i>28</i>
<b>CELESTIAL OBSERVING.....</b>	<b>29</b>
<i>Observing the Moon.....</i>	<i>29</i>
<i>Observing the Planets .....</i>	<i>29</i>

<i>Observing the Sun</i> .....	30
<i>Observing Deep Sky Objects</i> .....	30
<i>Seeing Conditions</i> .....	30
<i>Transparency</i> .....	30
<i>Sky Illumination</i> .....	30
<i>Seeing</i> .....	31
<b>CELESTIAL PHOTOGRAPHY</b> .....	<b>32</b>
<i>Short Exposure Prime Focus Photography</i> .....	32
<i>Eyepiece Projection</i> .....	33
<i>Long Exposure Prime Focus Photography</i> .....	34
<i>Terrestrial Photography</i> .....	35
<i>CCD Imaging</i> .....	36
<b>TELESCOPE MAINTENANCE</b> .....	<b>37</b>
<i>Care and Cleaning of the Optics</i> .....	37
<i>Collimation</i> .....	37
<b>OPTIONAL ACCESSORIES</b> .....	<b>39</b>
<b>APPENDIX A - TECHNICAL SPECIFICATIONS</b> .....	<b>42</b>
<b>APPENDIX B – GLOSSARY OF TERMS</b> .....	<b>43</b>
<b>APPENDIX C –LONGITUDES AND LATITUDES</b> .....	<b>46</b>
<b>APPENDIX D - RS-232 CONNECTION</b> .....	<b>51</b>
<b>APPENDIX E – MAPS OF TIME ZONES</b> .....	<b>52</b>
<b>SKY MAPS</b> .....	<b>54</b>



Congratulations on your purchase of the Celestron NexStar! The NexStar ushers in a whole new generation of computer automated technology. Simple and friendly to use, the NexStar is up and running after locating just two alignment stars. It's the perfect combination of power and portability. If you are new to astronomy, you may wish to start off by using the NexStar's built-in Sky Tour feature, which commands the NexStar to find the most interesting objects in the sky and automatically slews to each one. Or if you are an experienced amateur, you will appreciate the comprehensive database of over 18,000 objects, including customized lists of all the best deep-sky objects, bright double stars and variable stars. No matter at what level you are starting out, the NexStar will unfold for you and your friends all the wonders of the Universe.

Some of the many standard features of the NexStar include:

- Incredible 6°/second (or faster) slew speed.
- Fully enclosed optical encoders for position location.
- Integrated hand controller – built into the side of the fork arm.
- RS-232 port allows use with a computer and software programs like The Sky for point and click slewing.
- Storage for programmable user defined objects; and
- Many other high performance features!

The NexStar's deluxe features combine with Celestron's legendary Schmidt-Cassegrain optical system to give amateur astronomers one of the most sophisticated and easy to use telescopes available on the market today.

Take time to read through this manual before embarking on your journey through the Universe. It may take a few observing sessions to become familiar with your NexStar, so you should keep this manual handy until you have fully mastered your telescope's operation. The NexStar hand control has built-in instructions to guide you through all the alignment procedures needed to have the telescope up and running in minutes. Use this manual in conjunction with the on-screen instructions provided by the hand control. The manual gives detailed information regarding each step as well as needed reference material and helpful hints guaranteed to make your observing experience as simple and pleasurable as possible.

Your NexStar telescope is designed to give you years of fun and rewarding observations. However, there are a few things to consider before using your telescope that will ensure your safety and protect your equipment.

---

## Warning

- ❑ **Never look directly at the sun with the naked eye or with a telescope (unless you have the proper solar filter). Permanent and irreversible eye damage may result.**
- ❑ Never use your telescope to project an image of the sun onto any surface. Internal heat build-up can damage the telescope and any accessories attached to it.
- ❑ Never use an eyepiece solar filter or a Herschel wedge. Internal heat build-up inside the telescope can cause these devices to crack or break, allowing unfiltered sunlight to pass through to the eye.
- ❑ Never leave the telescope unsupervised, either when children are present or adults who may not be familiar with the correct operating procedures of your telescope.

# CELESTRON® Quick Setup

1



Remove the NexStar from its packaging and place the base on a sturdy, level surface or attach to tripod (see page 9). Remove the accessories from their individual boxes.

2

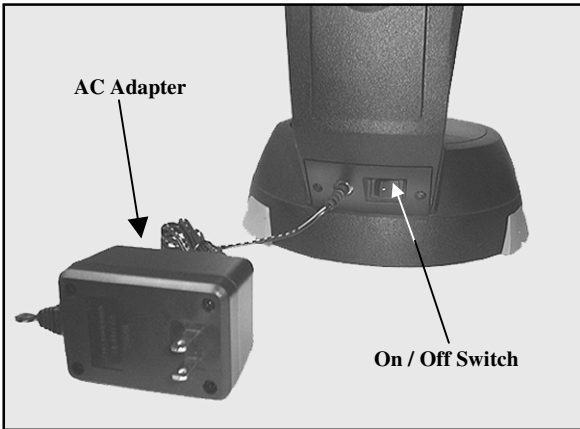

Plug-in the supplied 12v AC adapter\* into the jack at the base of the fork arm and an AC outlet. Power the NexStar by flipping the "On/Off" switch to the "On" position.

**\*Note:** Use only the AC adapter supplied by Celestron. Using any other adapter may damage the electronics and will void your manufacturer's warranty.

3



Press ENTER on the hand control to begin alignment. Use the Up and Down arrow buttons to position the tube horizontal to the ground. Attach the included accessories (star diagonal, eyepiece and Star Pointer finderscope) and remove the front lens cover. Turn on Star Pointer by rotating the dial on the side. (For instructions on aligning the Star Pointer see page 11).

4



Use the Up and Down scroll buttons to get to the *AutoAlign* menu. Press ENTER. Use the direction arrow keys to level the tube and rotate it towards North. (See *Astronomy Basics* for help on finding North). Input the necessary date and time information as instructed by the hand control. (See *Hand Control* section for complete instruction on entering data).

5

	LONGITUDE		LATITUDE	
	degrees	min	degrees	min
Torrance	118	19.8	33	48
Travis AFB	121	55.8	38	16.2
Tahoe	120	7.8	39	19.2

The first time the NexStar is used, the longitude and latitude must be entered into the hand control. When the display reads, *Select Location*, use Appendix C to look up the longitude and latitude of your nearest city and enter it into the hand control. When asked to *Save Location*, press ENTER and assign the number 1 to the current location. This number can be used for future alignments. (See page 14 for complete alignment procedures.)

7

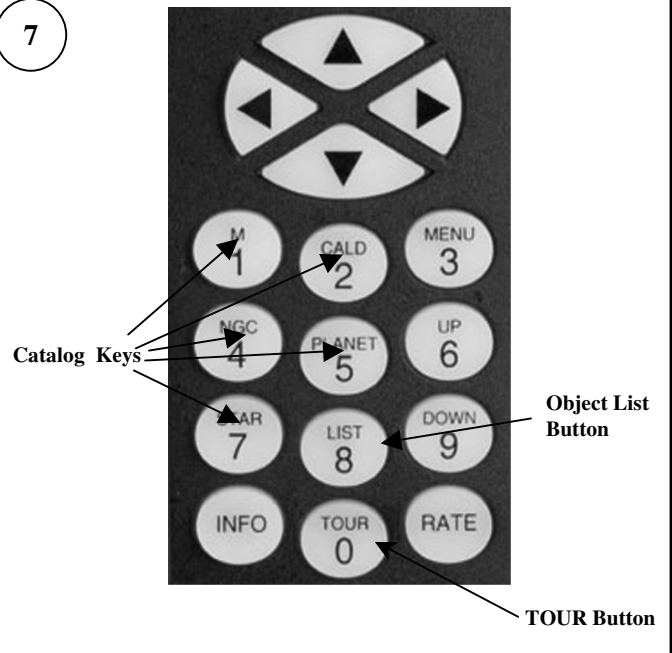

Press the TOUR button on the hand control. Use the Up and Down scroll keys to select the current month and press ENTER. The hand control will display the first object that is visible for that month. Press INFO to read information about the object displayed. Press the DOWN scroll key to display the next object. Press ENTER to slew to (go to) the displayed object.

6

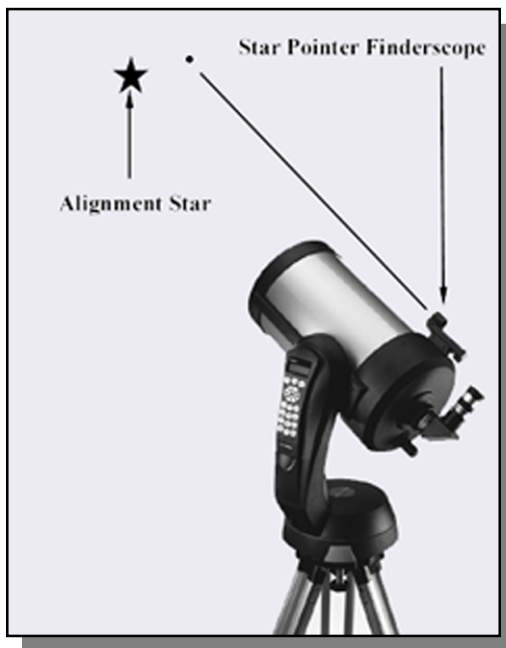

The NexStar will automatically pick an alignment star and slew the telescope close to that star. Once there, the display will ask you to use the arrow buttons to aim the Star Pointer at the star. If the star is not visible (perhaps behind a tree), press UNDO to select a new star. Next, center the star in the eyepiece and press ALIGN. Repeat these steps for the second star alignment. When complete, display will read "Alignment Successful".

8



Use the focus knob to bring objects into a sharp focus. Use arrow keys to center objects in the eyepiece. (See page 29 for observing hints and techniques).

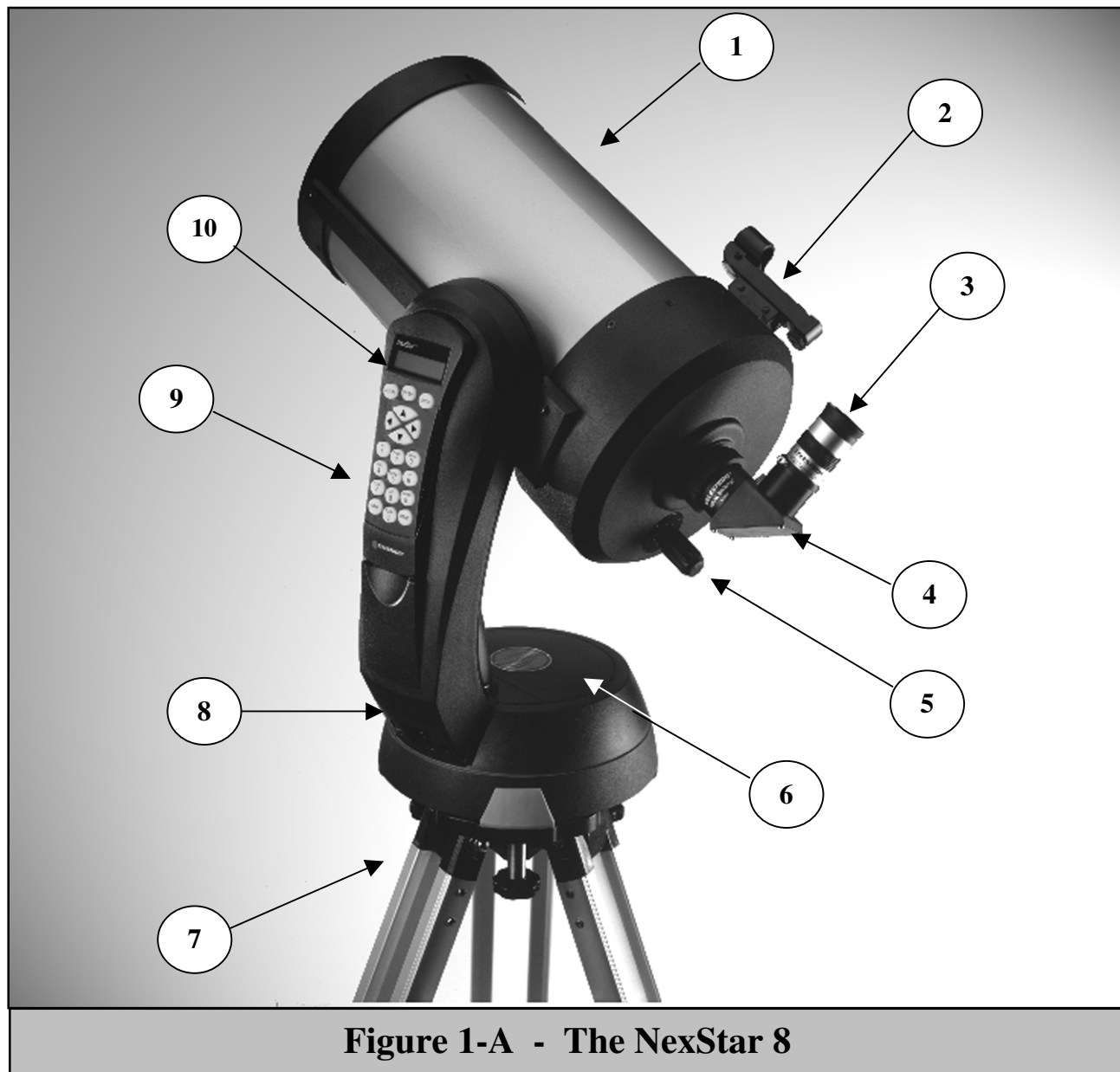

**Figure 1-A - The NexStar 8**

<b>1</b>	<b>Optical Tube</b>	<b>6</b>	<b>Battery Compartment</b>
<b>2</b>	<b>Star Pointer Finderscope</b>	<b>7</b>	<b>Tripod</b>
<b>3</b>	<b>Eyepiece</b>	<b>8</b>	<b>ON/OFF Switch</b>
<b>4</b>	<b>Star Diagonal</b>	<b>9</b>	<b>Hand Control</b>
<b>5</b>	<b>Focuser Knob</b>	<b>10</b>	<b>Liquid Crystal Display</b>



The NexStar comes completely pre-assembled and can be operational in a matter of minutes. The NexStar is conveniently packaged in one reusable shipping carton that contains all of the following accessories:

- 40mm Plossl Eyepiece – 1¼"
- 1¼" Star Diagonal
- Star Pointer Finderscope and Mounting Bracket
- 1¼" Visual Back (attached to the optical tube)
- AC adapter

## Assembling the NexStar

Start by removing the telescope from its shipping carton and setting the round base on a flat table or surface. It is best to carry the telescope by holding it from the lower portion of the fork arm and from the bottom of the base. **Do not try to move the optical tube OF at this time. It should remain facing upward until the telescope is powered up.** Remove all of the accessories from their individual boxes. Remember to save all of the containers so that they can be used to transport the telescope. Before attaching the visual accessories, the telescope tube should be positioned horizontal to the ground. To do this, the telescope needs to be powered up and the optical tube must be moved remotely with the hand control.

NOTE

*In case of a loss of power, the optical tube can be moved by hand. However, when powered on, the telescope should always be controlled via the hand control. The NexStar will lose its star alignment if moved by hand when powered on.*

## Powering the NexStar

The NexStar can be powered by the supplied 12v AC adapter or eight AA batteries (not included). Batteries should only be used when using the telescope out in the field, where AC power is not available. The battery compartment is located in the center of the telescope's base (see figure 3-1). Before the battery compartment can be removed, the telescope tube must first be moved into a horizontal position. Read the *Hand Control* section below before installing batteries.

To power the NexStar with the 12v AC adapter, simply plug the round post into the 12v outlet on the side of the fork arm and plug the adapter into any wall outlet. To install the batteries:

1. Remove the battery cover from the center of the base by gently lifting up on the round portion of the cover.
2. Insert the batteries into the battery compartment of the base.
3. Reattach the battery compartment door by gently pushing down on the cover until it snaps into place.
4. Turn on the power to the NexStar by flipping the switch, located next to the 12v outlet, to the "On" position.

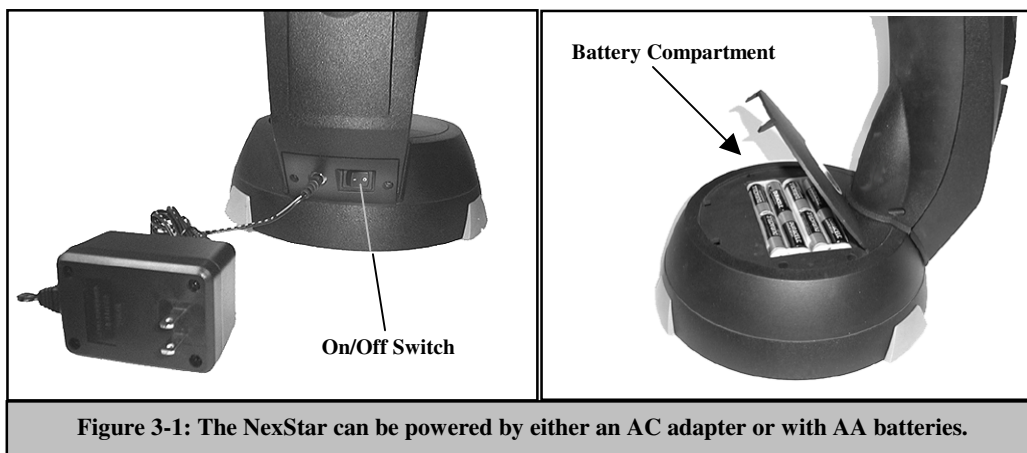



## Attaching the NexStar to the Tripod

The Celestron NexStar tripod is a sturdy, lightweight mount on which to place your NexStar telescope. Weighing less than 10 pounds, this tripod can go anywhere, from your backyard to a remote observing site.

To set up the tripod:

1. Hold the tripod with the head up, away from the ground.
2. Pull the legs apart until the support bracket is fully extended and press it down flat.

The tripod will now stand by itself.

Your tripod is adjustable. The height range is 31" to 54". For maximum rigidity, set the tripod height between 45" and 48". To adjust the height of the tripod:

1. Locate the hand tighten knobs on the bottom of each tripod leg.
2. Rotate the knob counterclockwise until the inside portion of the tripod leg slides out.
3. Extend the center portion of the tripod leg to the desired height.
4. Tighten the knob to hold the tripod leg in place.

With the tripod set up, you are ready to attach the accessory tray to the tripod.

There are three wing bolts that hold the accessory tray to the leg support bracket.

1. Locate the three wing bolts.
2. Place the accessory tray over the bracket and position it so the thread holes in the accessory tray are above the slotted holes in the bracket.
3. Insert the wing bolts up through the slotted holes in the bracket.
4. Thread the wing bolts into the holes in the accessory tray.
5. Tighten the wing bolts fully.
6. With the accessory tray in place, the tripod will be much more stable making it easier to attach the telescope.

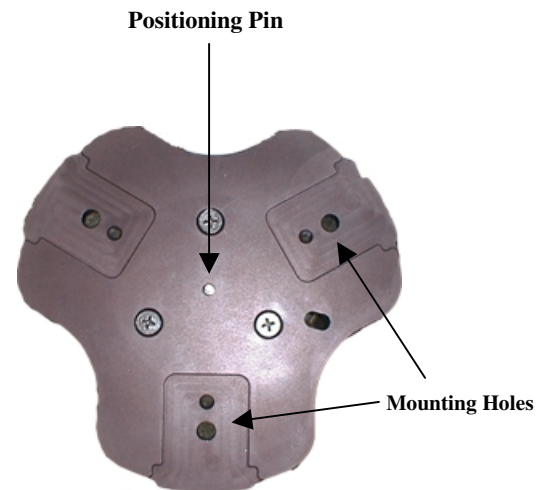

After the tripod is set up, you are now ready to attach the telescope. The bottom of the NexStar base has three threaded holes that mount to the tripod plate and one hole in the center that goes over the positioning pin on the tripod plate.

1. Place the center hole in the bottom of the telescope base over the positioning pin in the center of the tripod plate.
2. Rotate the telescope base until the rubber feet fit snugly into the recesses of the tripod plate and the threaded holes align with the holes in the tripod plate.
3. Thread the three locking bolts from underneath the tripod plate into the bottom of the telescope base. Tighten all three bolts. **Warning: Never insert bolts with threads longer than 3/8" into the NexStar base. It can cause damage to the internal motors.**

## The Hand Control

The hand control is located on the side of the fork arm and can be removed and used remotely or used while attached to the fork. The hand control attaches to the fork arm by resting on two posts, located on the bottom of the hand control cradle, and a clip inside the fork arm. To remove the hand control from the fork arm cradle, gently lift the hand control upwards and pull out. To return the hand control into the fork arm, lower the hand control into the cradle so that the two holes in the bottom of the hand

control go over the posts on the bottom of the cradle, and the opening in the back of the hand control slides over the clip inside the fork arm.

Once the telescope is powered up, use the hand control to move the optical tube to the horizontal position:

- Press UNDO. This will bypass the normal alignment procedures and will still allow you to control the telescope.
- Use the Up arrow directional button to move the telescope tube until it is roughly parallel to the ground. This will make it more convenient to attach the necessary accessories as well as remove the front lens cover and install batteries when they are needed.

You are now ready to attach the included visual accessories onto the telescope optical tube.

## ***The Star Diagonal***

The star diagonal diverts the light at a right angle from the light path of the telescope. For astronomical observing, this allows you to observe in positions that are more comfortable than if you were to look straight through. To attach the star diagonal:

1. Turn the thumbscrew on the visual back until its tip no longer extends into (i.e., obstructs) the inner diameter of the visual back.
2. Slide the chrome portion of the star diagonal into the visual back.
3. Tighten the thumbscrew on the visual back to hold the star diagonal in place.

If you wish to change the orientation of the star diagonal, loosen the thumbscrew on the visual back until the star diagonal rotates freely. Rotate the diagonal to the desired position and tighten the thumbscrew.

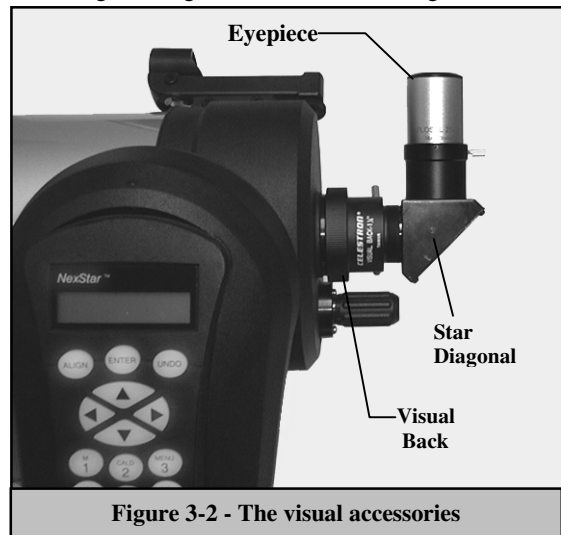

**Figure 3-2 - The visual accessories**

## ***The Eyepiece***

The eyepiece, or ocular, is the optical element that magnifies the image focused by the telescope. The eyepiece fits into either the visual back directly or the star diagonal. To install the eyepiece:

1. Loosen the thumbscrew on the star diagonal so it does not obstruct the inner diameter of the eyepiece end of the diagonal.
2. Slide the chrome portion of the eyepiece into the star diagonal.
3. Tighten the thumbscrew to hold the eyepiece in place.

To remove the eyepiece, loosen the thumbscrew on the star diagonal and slide the eyepiece out.

Eyepieces are commonly referred to by focal length and barrel diameter. The focal length of each eyepiece is printed on the eyepiece barrel. The longer the focal length (i.e., the larger the number) the lower the eyepiece power or magnification; and the shorter the focal length (i.e., the smaller the number) the higher the magnification. Generally, you will use low-to-moderate power when viewing. For more information on how to determine power, see the section on “Calculating Magnification.”

Barrel diameter is the diameter of the barrel that slides into the star diagonal or visual back. The NexStar uses eyepieces with a standard 1-1/4" barrel diameter.

## The Star Pointer Finderscope

The Star Pointer is the quickest and easiest way to point your telescope exactly at a desired object in the sky. It's like having a laser pointer that you can shine directly onto the night sky. The Star Pointer is a zero magnification pointing tool that uses a coated glass window to superimpose the image of a small red dot onto the night sky. While keeping both eyes open when looking through the Star Pointer, simply move your telescope until the red dot, seen through the Star Pointer, merges with the object as seen with your unaided eye. The red dot is produced by a light-emitting diode (LED); it is not a laser beam and will not damage the glass window or your eye. The Star Pointer comes equipped with a variable brightness control, two axes alignment control and two quick-release dovetail mounting brackets (one for the NexStar telescope and one for mounting the Star Pointer on other sized telescopes). Before the Star Pointer is ready to be used, it must be attached to the telescope tube and properly aligned:

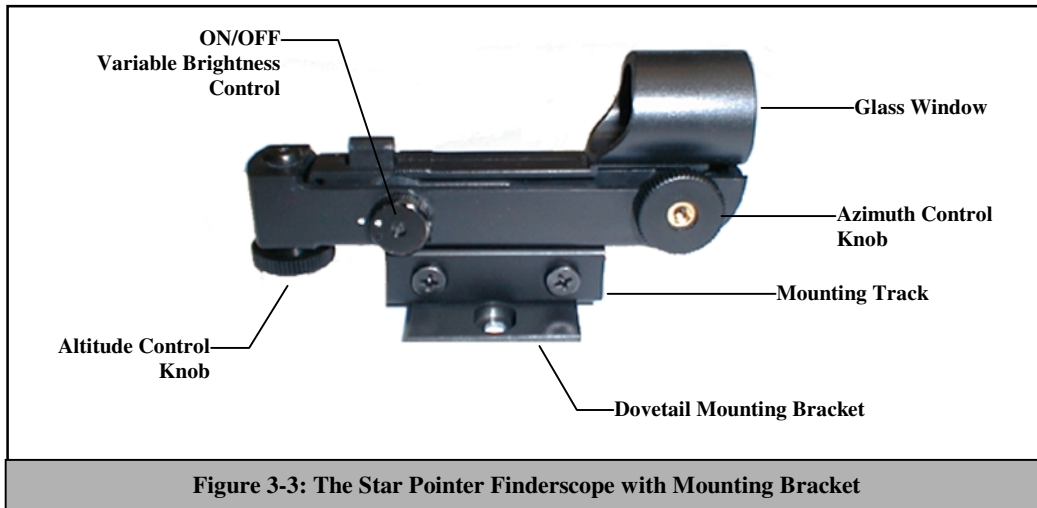

### Star Pointer Installation

1. First, remove the two 8-32 x 1/4" screws located on the top portion of the telescope's rear cell.
2. Locate the square dovetail bracket that has the proper curvature for the NexStar tube and align the holes with the two holes in the telescope body.
3. Use the two 8-32 x 1/4" screws to tighten down the bracket to the rear cell.
4. Once the bracket is mounted, slide the mounting track at the bottom of the Star Pointer over the dovetail portion of the bracket. It may be necessary to loosen the two screws on the side of the mounting track before sliding it over the dovetail. The end of the Star Pointer with the glass window should be facing out towards the front of the telescope.
5. Tighten the two screws on the side of the mounting track to secure the Star Pointer to the dovetail bracket.

### Star Pointer Operation

The star pointer is powered by a long life 3-volt lithium battery (#CR2032) located underneath the front portion of the Star Pointer. Like all finderscopes, the Star Pointer must be properly aligned with the main telescope before it can be used. This is a simple process using the azimuth and altitude control knobs located on the side and bottom of the Star Pointer. The alignment procedure is best done at night since the LED dot will be difficult to see during the day.

1. To turn on the Star Pointer, rotate the variable brightness control (see figure 3-3) clockwise until you here a "click". To increase the brightness level of the red dot, continue rotating the control knob about 180° until it stops.
2. Locate a bright star or planet and center it in a low power eyepiece in the main telescope.
3. With both eyes open, look through the glass window at the alignment star.

4. If the Star Pointer is perfectly aligned, you will see the red LED dot overlap the alignment star. If the Star Pointer is not aligned, take notice of where the red dot is relative to the bright star.
5. Without moving the main telescope, turn the Star Pointer's azimuth and altitude alignment controls until the red dot is directly over the alignment star.

If the LED dot is brighter than the alignment star, it may make it difficult to see the star. Turn the variable brightness control counterclockwise, until the red dot is the same brightness as the alignment star. This will make it easier to get an accurate alignment. The Star Pointer is now ready to be used . **Remember to always turn the power off after you have found an object. This will extend the life of both the battery and the LED.**

**CELESTRON<sup>®</sup>**  
**Hand Control**

The NexStar has a removable hand controller built into the side of the fork arm designed to give you instant access to all the functions the NexStar has to offer. With automatic slewing to over 18,000 objects, and common sense menu descriptions, even a beginner can master its variety of features in just a few observing sessions. Below is a brief description of the individual components of the NexStar hand controller:

**Liquid Crystal Display (LCD) Window:** Has a dual-line, 16 character display screen that is backlit for comfortable viewing of telescope information and scrolling text.

**Align:** Instructs the NexStar to use a selected star or object as an alignment position.

**Direction Keys:** Allows complete control of the NexStar in any direction. Use the direction keys to move the telescope to the initial alignment stars or for centering objects in the eyepiece.

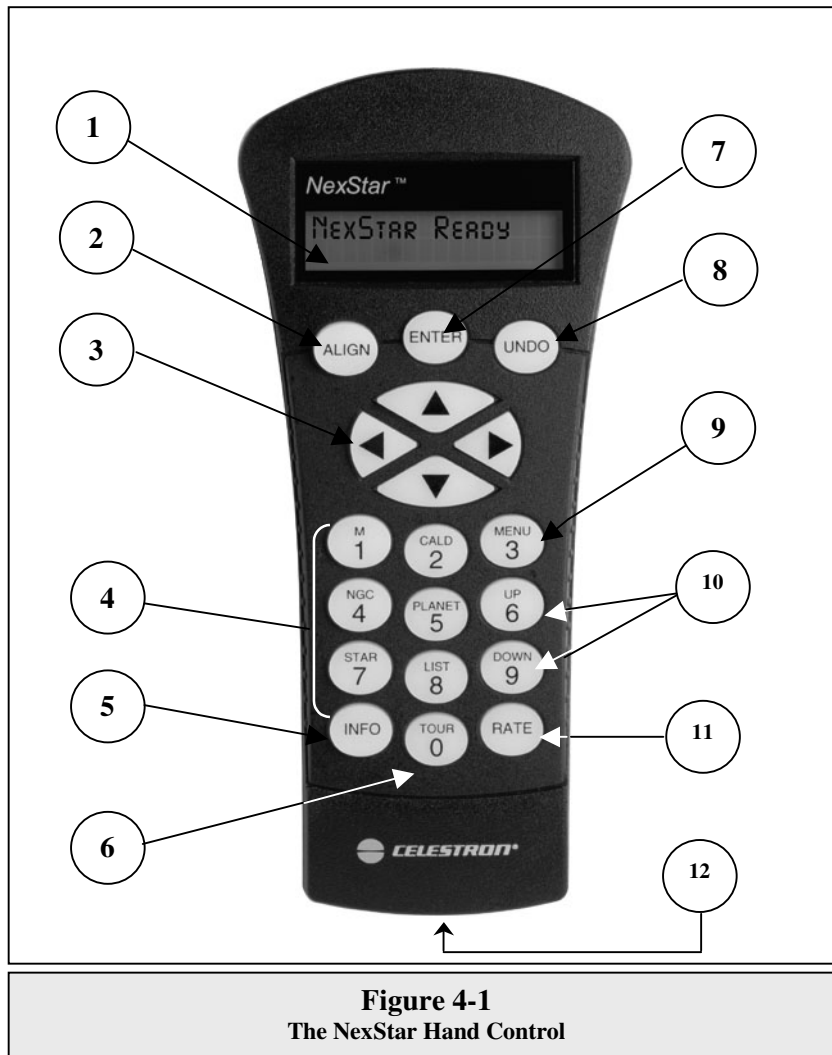

**Figure 4-1**  
**The NexStar Hand Control**

**Catalog Keys:** The NexStar has keys on the hand control to allow direct access to each of the catalogs in its 18,000+ object database. The NexStar contains the following catalogs in its database:

*Messier* – Complete list of all Messier objects.

*NGC* – Complete list of all the deep-sky objects in the Revised New General Catalog.

**Caldwell** – A combination of the best NGC and IC objects.

**Planets** - All 8 planets in our Solar System plus the Sun.

**Stars** – A compiled list of the brightest stars from the SAO catalog.

**List** – For quick access, all of the best and most popular objects in the NexStar database have been broken down into lists based on their type and/or common name:

<b>Alignment Stars</b>	Common name listing of the brightest stars in the sky.
<b>Named Objects</b>	Alphabetical listing of over 50 of the most popular deep sky objects.
<b>Double Stars</b>	Numeric-alphabetical listing of the most visually stunning double, triple and quadruple stars in the sky.
<b>Variable Stars</b>	Select list of the brightest variable stars with the shortest period of changing magnitude.
<b>Asterisms</b>	A unique list of some of the most recognizable star patterns in the sky.

**Info:** Displays coordinates and useful information about objects selected from the NexStar database.

**Tour:** Activates the tour mode, which seeks out all the best objects for a given month and automatically slews the NexStar to those objects.

**Enter:** Pressing *Enter* allows you to select any of the NexStar functions and accept entered parameters.

**Undo:** *Undo* will take you out of the current menu and display the previous level of the menu path. Press *Undo* repeatedly to get back to a main menu or use it to erase data entered by mistake.

**Menu:** Displays the many setup and utilities functions such as tracking rate and user defined objects and many others.

**Scroll Keys:** Used to scroll up and down within any of the menu lists. A double-arrow will appear on the right side of the LCD when there are sub-menus below the displayed menu. Using these keys will scroll through those sub-menus.

**Rate:** Instantly changes the rate of speed of the motors when the direction buttons are pressed.

**RS-232 Jack:** Allows use with a computer and software programs like *The Sky* for point and click slewing.

## Hand Control Operation

This section describes the basic hand control procedures needed to operate the NexStar. These procedures are grouped into three categories: Alignment, Setup and Utilities. The alignment section deals with the initial telescope alignment as well as finding objects in the sky; the setup section discusses changing parameters such as tracking mode and tracking rate; finally, the last section reviews all of the utilities functions such as the RS-232 connection, activating the cord wrap feature and backlash compensation.

### Alignment Procedure

In order for the NexStar to accurately point to objects in the sky, it must first be aligned to two known positions (stars) in the sky. With this information, the telescope can create a model of the sky, which it uses to locate any object with known coordinates. There are two ways to align the NexStar with the sky depending on what information the user is able to provide. If you know the names of two bright, visible stars in the sky, you can use the two-star alignment method; if you do not know the names of two stars in the sky, you can enter the longitude and latitude (provided in Appendix C) of your observing location and NexStar will auto-align itself to two stars in the sky for you.

#### Two Star Alignment

With the two-star alignment method, the NexStar requires the user to know the positions of only two bright stars in order to accurately align the telescope with the sky and begin finding objects. Once the telescope is powered on, the LCD display will guide you through all the steps to align the telescope properly. Before the telescope is ready to be aligned, it should be set up in an outside location with all accessories (eyepiece, diagonal and Star Pointer) attached and lens cover removed as described in the Assembly section of the manual. Here is an overview of the alignment procedure:

1. Once the NexStar is powered on, Press **ENTER** to begin alignment.
2. Use the Up and Down scroll keys to select **Two Star Align**, and press **ENTER**.
3. The NexStar display will ask you to move the telescope tube until it is horizontal to the ground. To do this, use the direction keys (3) to move the telescope until it is roughly level with the ground. Press **ENTER**.
4. The **SELECT STAR 1** message will appear in the top row of the display. Use the up and down scroll keys (10) to select the star you wish to use for the first alignment star. Press **ENTER**.

**Helpful Hint**

NexStar then asks you to center in the eyepiece the alignment star you selected. Use the direction buttons to slew the telescope to the alignment star.

*In order to accurately center the alignment star in the eyepiece, it will be necessary to decrease the slew rate of the motors for fine centering. This is done by pressing the RATE key (11) on the hand controller then selecting the number that corresponds to the speed you desire. (9 = fastest, 1 = slowest).*

Once the alignment star is centered in the field of view of the eyepiece, press the ALIGN key (2) to accept this position. NexStar will then ask you to select and center a second alignment star and press the ALIGN key. It is best to choose alignment stars that are a good distance away from one another. Stars that are at least 40° to 60° apart from each other will give you a more accurate alignment than stars that are close to each other.

Once the second star alignment is completed properly, the display will read **Alignment Successful**, and you will hear the tracking motors turn-on and begin to track.

## Auto-Align

Alternatively, if you do not know the names of two bright stars, you can align the telescope by entering the longitude and latitude of your observing location, and the NexStar will automatically choose two stars for alignment and roughly center the stars in the field of view of the Star Pointer. Once again the telescope should be set up outside with all accessories attached and the lens cover removed.

1. Once the NexStar is powered on, Press ENTER to begin alignment.
2. Use the Up and Down scroll keys to select AutoAlign if it is not already displayed, and press ENTER.
3. The telescope will then ask you to use the arrow keys (10) to level the telescope tube and point the front of the telescope towards north. North can be found by finding the direction of the North Star (Polaris) or by using a compass. You do not need to point at the North Star, only the north horizon. For help finding the direction of the North Star, see the Astronomy Basics section of the manual. Alignment only needs to be approximate, however a close alignment will make the auto alignment more accurate.
4. The hand control display will then ask for the following information:

**Date** - Enter the month, day and year of your observing session. The display will read: mm/dd/yy

**Time** - Enter the current local time for your area. You can enter either the local time (i.e. 08:00), or you can enter military time (i.e. 20:00).

Select PM or AM. If military time was entered, the hand control will bypass this step.

Choose between Standard time or Daylight Savings time. Use the Up and Down scroll buttons (10) to toggle between options.

Select the time zone that you are observing from. Again, use the Up and Down buttons (10) to scroll through the choices.

*If you enter any of the alignment information incorrectly, pressing UNDO acts as a backspace button, and will back the cursor to its previous position allowing you to re-enter any necessary information.*

Finally, you must enter the longitude and latitude of the location of your observing site. The coordinates can be obtained from a listing in the appendix of this manual. These coordinates can be saved so that the longitude and latitude only has to be entered once from any given location.

1. Press ENTER at the **Select Location** display.
2. Use the Up and Down scroll keys to select **Enter Long/Lat**, if it is not already displayed.
3. Use the table in Appendix C to locate the closest longitude and latitude for your current observing location and enter those numbers when asked in the hand control, pressing ENTER after each entry.

The display will then ask if you would like to save these coordinates for future use. If you press "Yes", the next time you AutoAlign the telescope, you can choose **User Defined** instead of the **Enter Long/Lat**, and enter the number for that observing location. To save the entered longitude and latitude, simply press "Yes" and enter a number from 0-9. Pressing ENTER will assign that number to your current position.

Based on this information, the NexStar will automatically select a bright star that is above the horizon and slew towards it. At this point the telescope is only roughly aligned, so the alignment star should only be close to the field of view of the Star Pointer finder. Once finished slewing, the display will ask you to use the arrow buttons to center the selected star with the red dot in the center of the Star Pointer. If for some reason the chosen star is not visible (perhaps behind a tree or building) you can press UNDO to select and slew to a different star. Once centered in the finder, press ENTER. The display will then instruct you to center the star in the field of view of the eyepiece. When the star is centered, press ALIGN to accept this star as an alignment star. (There is no need to adjust the slewing rate of the motors after each alignment step. The NexStar automatically selects the best

slewing rate for aligning objects in both the Star Pointer and the eyepiece). After the first alignment star has been entered the NexStar will automatically slew to a second alignment star and have you repeat this procedure for that star. When the telescope has been aligned to both stars the display will read "**Alignment Successful**", and you are now ready to find your first object.

#### Trouble Shooting

If the wrong star was centered and aligned to, the NexStar display will read Bad Alignment. Should this occur, the display will automatically ask you to re-center the last alignment star and press ALIGN. If you believe that the wrong star may have been centered (remember the alignment star will always be the brightest star nearest the field of view of the finder), then re-center the star and press ALIGN. If you wish to try aligning on a different star, press UNDO and the NexStar will select two new alignment stars and automatically slew to the first star.

## Third Star Alignment

The NexStar has a third star alignment feature which allows you to replace either of the two original alignment stars with a new star. This can be useful in several situations:

- If you are observing over a period of a few hours, you may notice that your original two alignment stars have drifted towards the west considerably. (Remember that the stars are moving at a rate of 15° every hour). Aligning on a new star that is in the eastern part of the sky will improve your pointing accuracy, especially on objects in that part of the sky.
- When trying to locate a very faint or small object that may be difficult to find in the eyepiece, you can improve your pointing accuracy by aligning to a third star that is nearest to the object you are trying to find.

To replace an existing alignment star with a new alignment star:

1. Locate and center the desired star in the eyepiece.
2. Press the ALIGN key on the hand control.
3. The display will then ask you which alignment star you want to replace.
4. Use the UP and Down scroll keys to select the alignment star to be replaced. It is usually best to replace the star closest to the new star. This will space out your alignment stars across the sky.
5. Press ENTER to make the change.

## Object Catalog

### Selecting an Object

Now that the telescope is properly aligned, you can choose an object from any of the catalogs in the NexStar's extensive database. The hand control has a key (4) designated for each of the catalogs in its database. There are two ways to select objects from the database: scrolling through the named object lists and entering object numbers.

1. Pressing the LIST key on the hand control will access all objects in the database that have common names or types. Each list is broken down into the following categories: Named Stars, Named Object, Double Stars, Variable Stars and Asterisms. Selecting any one of these options will display a numeric-alphabetical listing of the objects under that list. Pressing the Up and Down keys (10) allows you to scroll through the catalog to the desired object.

*When scrolling through a long list of objects, holding down either the Up or Down key will allow you to scroll through the catalog at a rapid speed.*

2. Pressing any of the other catalog keys (M, CALD, NGC, or STAR) will display a blinking cursor below the name of the catalog chosen. Use the numeric key pad to enter the number of any object within these standardized catalogs. For example, to find the Orion Nebula, press the "M" key and enter "042".

To download a list of all the stars contained in the STAR Catalog with SAO number cross references, logon to our web site at [www.celestron.com](http://www.celestron.com) and go to the NexStar page.

#### Helpful Hint

#### More Information



## Slewing to an Object

Once the desired object is displayed in the hand control screen, you have two options:

1. **Press the INFO Key.** This will give you useful information about the selected object such as R.A. and declination, magnitude and most importantly, altitude above the horizon. (If a star alignment has not yet been performed, the altitude will not be displayed).
2. **Press the ENTER Key.** This will automatically slew the telescope to the coordinates of the object.

**Caution: Never slew the telescope when someone is looking into the eyepiece. The telescope can move at very fast slew speeds and may hit an observer in the eye.**

*If you are in Alt-Az tracking mode and slew to an object that below the horizon, NexStar will notify you by scrolling the following message on the hand control display, "Position requested is below horizon". To cancel the slew, press the UNDO button. By pressing ENTER the NexStar will allow you to slew to objects below the horizon, however if you try to slew to an object below -45 degrees in altitude, the hand control will display the additional warning, "NexStar tube may hit base". It is recommended that the slew be canceled by pressing UNDO rather than letting the tube come into contact with the telescope base.*

Object information can be obtained without having to do a star alignment. After the telescope is powered on, press the UNDO key. Pressing any of the catalog keys allows you to scroll through object lists or enter catalog numbers as described above. However, information such as R.A. and declination of planets and altitude above the horizon will not be displayed unless the telescope is first properly aligned.

There are two special object catalogs which require the input of additional information before the NexStar can slew to the object; they are Planet and Tour:

## Finding Planets

Since the planets are not fixed points in the sky, but rather appear to move relative to the background stars, the NexStar needs to have time and date information before it can go to any solar system object. To locate the planets, press the PLANET key on the hand control. The on screen display will ask for the following information:

- Date** - Enter the month, day and year of your observing session.
- Time** - Enter the current local time for your area.  
Select PM or AM.  
Choose between Standard time or Daylight Savings time.  
Select the time zone that you are observing from.

Once this information is entered, use the Up and Down keys to select the Planet that you wish to observe. Press ENTER.

If *AutoAlign* was used to align the telescope, all the necessary information has already been entered into the hand control and you are ready to select a planet to observe.

## Tour Mode

The NexStar includes a tour feature which automatically allows the user to choose from a list of interesting objects based on the month in which you are observing. The Tour mode is activated by pressing the TOUR key (6) on the hand control. Once activated, simply use the scroll keys to select the current month and press ENTER. The NexStar will display from a list of the best objects to observe based on the month entered.

- To see information and data about the displayed object, press the INFO key.
- To slew to the object displayed, press ENTER.
- To see the next tour object, press the Up key.



**Observing  
Tip**

When going through any of the object catalogs in the database, you can easily find out which objects are above the horizon and visible simply by pressing the INFO button when the desired object is displayed. This will display the objects altitude above the horizon based on the date and time entered. Pressing the UP button once will display any scrolling text associated with that object. The scrolling text can be viewed even if a star alignment has not been performed.

## Direction Buttons

The NexStar has four direction buttons in the center of the hand control which control the telescope motion in altitude (up and down) and azimuth (left and right). The telescope can be controlled at nine different speed rates.

## Rate Button

Pressing the RATE key (11) allows you to instantly change the speed rate of the motors from high speed slew rate to precise guiding rate or anywhere in between. Each rate corresponds to a number on the hand controller key pad. The number 9 is the fastest rate (6° per second, depending on power source) and is used for slewing between objects and locating alignment stars. The number 1 on the hand control is the slowest rate (1x sidereal) and can be used for accurate centering of objects in the eyepiece and photographic guiding. To change the speed rate of the motors:

- Press the RATE key on the hand control. The LCD will display the current speed rate.
- Press the number on the hand control that corresponds to the desired speed. The LCD will display "NexStar Ready" indicating that the rate has been changed.

The hand control has a "double button" feature that allows you to instantly speed up the motors without having to choose a speed rate. To use this feature, simply press the arrow button that corresponds to the direction that you want to move the telescope. While holding that button down, press the opposite directional button. This will increase the slew rate to approximately 1.5° per second (equal to rate 7 on the hand control). This feature will not function if the telescope is currently set at a speed rate of 8 or 9.

The slower slew rates (6 and lower) move the motors in the opposite direction than the faster slew rates (8 and 9). This is done so that an object will move in the appropriate direction when looking into the eyepiece (i.e. pressing the right arrow button will move the star towards the right in the field of view of the eyepiece). However, if any of the slower slew rates (rate 6 and below) are used to center an object in the Star Pointer, you may need to press the opposite directional button to make the telescope move in the correct direction.

<i>1 = 1x (sidereal)</i>	<i>6 = 128x</i>
<i>2 = 2x</i>	<i>7 = 1.5° / sec</i>
<i>3 = 8x</i>	<i>8 = 3° / sec</i>
<i>4 = 16x</i>	<i>9 = 6.5° / sec</i>
<i>5 = 64x</i>	
<b>Nine available slew speeds</b>	

## Setup Procedures

The NexStar contains many user defined setup functions designed to give the user control over the telescope's many advanced features. All of the setup and utility features can be accessed by pressing the MENU key and scrolling through the options:

**Tracking Mode** This allows you to change the way the telescope tracks depending on the type of mount being used to support the telescope. The NexStar has three different tracking modes:

- Alt-Az** This is the default tracking rate and is used when the telescope is placed on a flat surface or tripod without the use of an equatorial wedge. The telescope must be aligned with two stars before it can track in Alt-Az.
- EQ North** Used to track the sky when the telescope is polar aligned using an equatorial wedge in the Northern Hemisphere.
- EQ South** Used to track the sky when the telescope is polar aligned using an equatorial wedge in the Southern Hemisphere.
- Off** When using the telescope for terrestrial (land) observation, the tracking can be turned off so that the telescope never moves.

**Tracking Rate** In addition to being able to move the telescope with the hand control buttons, the NexStar will continually track a celestial object as it moves across the night sky. The tracking rate can be changed depending on what type of object is being observed:

**Sidereal** This rate compensates for the rotation of the earth by moving the telescope at the same rate as the rotation of the earth, but in the opposite direction. When the telescope is polar aligned, this can be accomplished by moving the telescope in Right Ascension only. When mounted in Alt-Az mode, the telescope must make corrections in both R.A. and declination.

**Lunar** Used for tracking the moon when observing the lunar landscape.

**Solar** Used for tracking the Sun when solar observing.

**King** As light passes through our atmosphere, atmospheric refraction affects the apparent motion of objects across the sky. The King rate takes this into account and compensates for the refraction of the atmosphere.

**Date/Time** - Allows you to update both the date and the time to improve pointing accuracy on many objects.

## User Defined Objects

The NexStar can store up to 25 different user defined objects in its memory. The objects can be daytime land objects or an interesting celestial object that you discover that is not included in the regular database. There are several ways to save an object to memory depending on what type of object it is:

**Save Sky Object:** The NexStar stores celestial objects to its database by saving its right ascension and declination in the sky. This way the same object can be found each time the telescope is aligned. Once a desired object is centered in the eyepiece, simply scroll to the "**Save Sky Obj**" command and press ENTER. The display will ask you to enter a number between 1-20 to identify the object. Press ENTER again to save this object to the database.

**Save Land Object:** The NexStar can also be used as a spotting scope on terrestrial objects. Fixed land objects can be stored by saving their altitude and azimuth relative to the location of the telescope at the time of observing. Since these objects are relative to the location of the telescope, they are only valid for that exact location. To save land objects, once again center the desired object in the eyepiece. Scroll down to the "**Save Land Obj**" command and press ENTER. The display will ask you to enter a number between 21-25 to identify the object. Press ENTER again to save this object to the database.

**Enter R.A. - Dec:** You can also store a specific set of coordinates for an object just by entering the R.A. and declination for that object. Scroll to the "**Enter RA-DEC**" command and press ENTER. The display will then ask you to enter first the R.A. and then the declination of the desired object.

**GoTo Object:** To go to any of the user defined objects stored in the database, scroll down to "**GoTo Obj**" and enter the number of the object you wish to select and press ENTER. NexStar will automatically retrieve the coordinates and slew to the object.

To replace the contents of any of the user defined objects, simply save a new object using one of the existing identification numbers; NexStar will replace the previous user defined object with the current one.

**Get RA/DEC** - Displays the right ascension and declination for the current position of the telescope.

**Get Alt-Az** - Displays the relative altitude and azimuth for the current position of the telescope.

**Goto R.A/ Dec** - Allows you to input a specific R.A. and declination and slew to it.

**Goto Alt-Az** - Allows you to enter a specific altitude and azimuth position and slew to it.

Helpful  
Hint

To store a set of coordinates (R.A./Dec) permanently into the NexStar database, save it as a *User Defined Object* as described above.

## Utility Features

Scrolling through the MENU options will also provide access to several advanced utility functions within the NexStar such as; motor demo, RS-232 interface, key pad light control, cord wrap and anti-backlash.

**Demo** - This feature will test both the altitude and azimuth motors by slewing to randomly chosen coordinates in the sky.

**RS-232** – The NexStar has an RS-232 port allowing it to communicate with many astronomy computer programs (such as *The Sky* by Software Bisque). Before attempting to create a link with a computer or laptop, go to the RS-232 option and press ENTER. Follow the connection procedures outlined by your software instructions.

**Light Control** – This feature allows you to turn off both the red key pad light and LCD display for daytime use to conserve power and to help preserve your night vision.

**Cord Wrap** – Cord wrap safeguards against the telescope slewing more than 360° in azimuth and wrapping the power cord around the base of the telescope. By default, the cord wrap feature is active when the telescope is powered on. Cord wrap should be turned off when powering the NexStar with batteries.

**Anti-backlash** – All mechanical gears have a certain amount of backlash or play between the gears. This play is evident by how long it takes for a star to move in the eyepiece when the hand control arrow buttons are pressed (especially when changing directions). The NexStar's anti-backlash features allows the user to compensate for backlash by inputting a value which quickly rewinds the motors just enough to eliminate the play between gears. The amount of compensation needed depends on the slewing rate selected; the slower the slewing rate the longer it will take for the star to appear to move in the eyepiece. Therefore, the anti-backlash compensation will have to be set higher. You will need to experiment with different values; a value between 20 and 50 is usually best for most visual observing, whereas a higher value may be necessary for photographic guiding.

To set the anti-backlash value, scroll down to the anti-backlash option and press ENTER. Enter a value from 0-100 for both azimuth and altitude and press ENTER after each one to save these values. NexStar will remember these values and use them each time it is turned on until they are changed.

Observing  
Tip

*For the best possible pointing accuracy, always center the alignment stars using the up arrow button and the right arrow button. Approaching the star from this direction when looking through the eyepiece will eliminate much of the backlash between the gears and assure the most accurate alignment possible.*

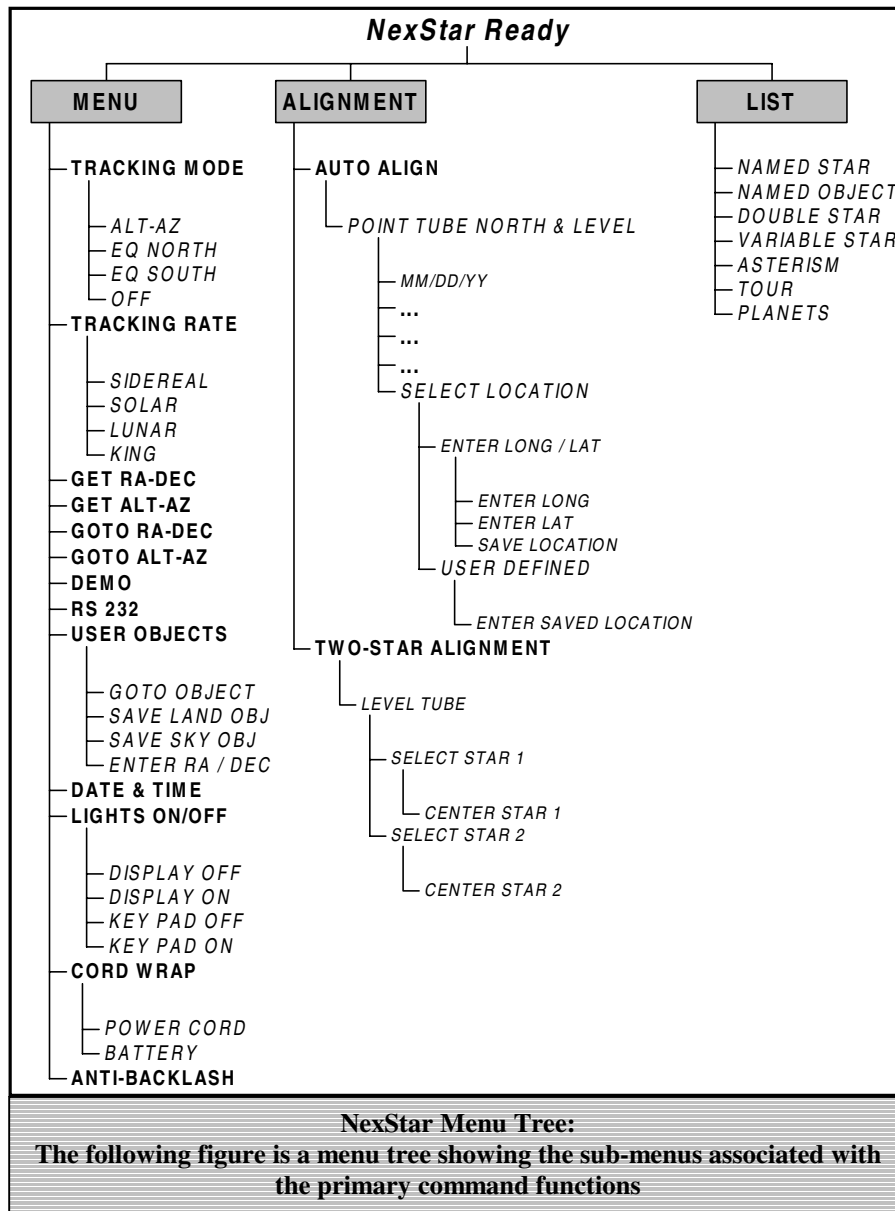



# Telescope Basics

A telescope is an instrument that collects and focuses light. The nature of the optical design determines how the light is focused. Some telescopes, known as refractors, use lenses. Other telescopes, known as reflectors, use mirrors. The Schmidt-Cassegrain optical system (or Schmidt-Cass for short) uses a combination of mirrors and lenses and is referred to as a compound or catadioptric telescope. This unique design offers large-diameter optics while maintaining very short tube lengths, making them extremely portable. The Schmidt-Cassegrain system consists of a zero power corrector plate, a spherical primary mirror, and a secondary mirror. Once light rays enter the optical system, they travel the length of the optical tube three times.

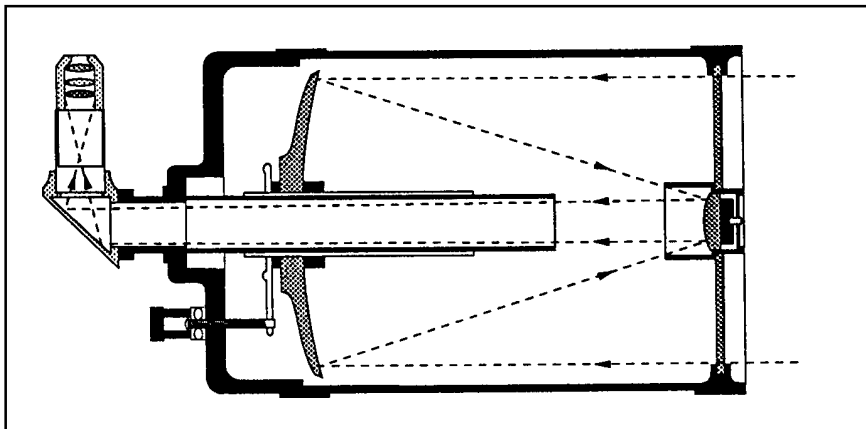

**Figure 5-1**

*A cutaway view of the light path of the Schmidt-Cassegrain optical design*

The optics of the NexStar have Starbright coatings - enhanced multi-layer coatings on the primary and secondary mirrors for increased reflectivity and a fully coated corrector for the finest anti-reflection characteristics.

Inside the optical tube, a black tube extends out from the center hole in the primary mirror. This is the primary baffle tube and it prevents stray light from passing through to the eyepiece or camera.

## Image Orientation

The image orientation changes depending on how the eyepiece is inserted into the telescope. When using the star diagonal, the image is right-side-up, but reversed from left-to-right (i.e., reverted). If inserting the eyepiece directly into the visual back (i.e., without the star diagonal), the image is upside-down and reversed from left-to-right (i.e., inverted). This is normal for the Schmidt-Cassegrain design.

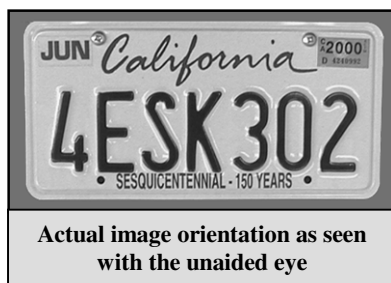

**Actual image orientation as seen with the unaided eye**



**Reversed from left to right, as viewed with a Star Diagonal**



**Inverted image, as viewed with the eyepiece directly in telescope**

**Figure 5-2**

## Focusing

The NexStar's focusing mechanism controls the primary mirror which is mounted on a ring that slides back and forth on the primary baffle tube. The focusing knob, which moves the primary mirror, is on the rear cell of the telescope just below the star diagonal and eyepiece. Turn the focusing knob until the image is sharp. If the knob will not turn, it has reached the end of its travel on the focusing mechanism. Turn the knob in the opposite direction until the image is sharp. Once an image is in focus, turn the knob clockwise to focus on a closer object and counterclockwise for a more distant object. A single turn of the focusing knob moves the primary mirror only slightly. Therefore, it will take many turns (about 30) to go from close focus (approximately 25 feet) to infinity.

For astronomical viewing, out of focus star images are very diffuse, making them difficult to see. If you turn the focus knob too quickly, you can go right through focus without seeing the image. To avoid this problem, your first astronomical target should be a bright object (like the Moon or a planet) so that the image is visible even when out of focus. Critical focusing is best accomplished when the focusing knob is turned in such a manner that the mirror moves against the pull of gravity. In doing so, any mirror shift is minimized. For astronomical observing, both visually and photographically, this is done by turning the focus knob counterclockwise.

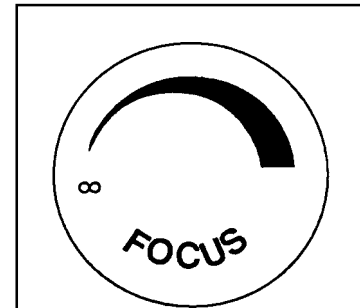

**Figure 5-3**  
The emblem on the end of the focus knob shows the correct rotational direction for focusing the NexStar.

## Calculating Magnification

You can change the power of your telescope just by changing the eyepiece (ocular). To determine the magnification of your telescope, simply divide the focal length of the telescope by the focal length of the eyepiece used. In equation format, the formula looks like this:

$$\text{Magnification} = \frac{\text{Focal Length of Telescope (mm)}}{\text{Focal Length of Eyepiece (mm)}}$$

Let's say, for example, you are using the 40mm Plossl eyepiece. To determine the magnification you simply divide the focal length of your telescope (the NexStar 8 has a focal length of 2000mm) by the focal length of the eyepiece, 40mm. Dividing 2000 by 40 yields a magnification of 50 power.

Although the power is variable, each instrument under average skies has a limit to the highest useful magnification. The general rule is that 60 power can be used for every inch of aperture. For example, the NexStar is 8" in diameter. Multiplying 8 by 60 gives a maximum useful magnification of 480 power. Although this is the maximum useful magnification, most observing is done in the range of 20 to 35 power for every inch of aperture which is 160 to 280 times for the NexStar 8 telescope.

## Determining Field of View

Determining the field of view is important if you want to get an idea of the angular size of the object you are observing. To calculate the actual field of view, divide the apparent field of the eyepiece (supplied by the eyepiece manufacturer) by the magnification. In equation format, the formula looks like this:

$$\text{True Field} = \frac{\text{Apparent Field of Eyepiece}}{\text{Magnification}}$$

As you can see, before determining the field of view, you must calculate the magnification. Using the example in the previous section, we can determine the field of view using the same 40mm eyepiece. The 40mm Plossl eyepiece has an apparent field of view of 46°. Divide the 46° by the magnification, which is 50 power. This yields an actual field of .92°, or a little less than a full degree.

To convert degrees to feet at 1,000 yards, which is more useful for terrestrial observing, simply multiply by 52.5. Continuing with our example, multiply the angular field .92° by 52.5. This produces a linear field width of 48.3 feet at a distance of one thousand yards. The apparent field of each eyepiece that Celestron manufactures is found in the Celestron Accessory Catalog (#93685).

## **General Observing Hints**

When working with any optical instrument, there are a few things to remember to ensure you get the best possible image.

- Never look through window glass. Glass found in household windows is optically imperfect, and as a result, may vary in thickness from one part of a window to the next. This inconsistency can and will affect the ability to focus your telescope. In most cases you will not be able to achieve a truly sharp image, while in some cases, you may actually see a double image.
- Never look across or over objects that are producing heat waves. This includes asphalt parking lots on hot summer days or building rooftops.
- Hazy skies, fog, and mist can also make it difficult to focus when viewing terrestrially. The amount of detail seen under these conditions is greatly reduced. Also, when photographing under these conditions, the processed film may come out a little grainier than normal with lower contrast and underexposed.
- If you wear corrective lenses (specifically glasses), you may want to remove them when observing with an eyepiece attached to the telescope. When using a camera, however, you should always wear corrective lenses to ensure the sharpest possible focus. If you have astigmatism, corrective lenses must be worn at all times.



# **Astronomy Basics**

Up to this point, this manual covered the assembly and basic operation of your NexStar telescope. However, to understand your telescope more thoroughly, you need to know a little about the night sky. This section deals with observational astronomy in general and includes information on the night sky and polar alignment.

## **The Celestial Coordinate System**

To help find objects in the sky, astronomers use a celestial coordinate system that is similar to our geographical coordinate system here on Earth. The celestial coordinate system has poles, lines of longitude and latitude, and an equator. For the most part, these remain fixed against the background stars.

The celestial equator runs 360 degrees around the Earth and separates the northern celestial hemisphere from the southern. Like the Earth's equator, it bears a reading of zero degrees. On Earth this would be latitude. However, in the sky this is referred to as declination, or DEC for short. Lines of declination are named for their angular distance above and below the celestial equator. The lines are broken down into degrees, minutes of arc, and seconds of arc. Declination readings south of the equator carry a minus sign (-) in front of the coordinate and those north of the celestial equator are either blank (i.e., no designation) or preceded by a plus sign (+).

The celestial equivalent of longitude is called Right Ascension, or R.A. for short. Like the Earth's lines of longitude, they run from pole to pole and are evenly spaced 15 degrees apart. Although the longitude lines are separated by an angular distance, they are also a measure of time. Each line of longitude is one hour apart from the next. Since the Earth rotates once every 24 hours, there are 24 lines total. As a result, the R.A. coordinates are marked off in units of time. It begins with an arbitrary point in the constellation of Pisces designated as 0 hours, 0 minutes, 0 seconds. All other points are designated by how far (i.e., how long) they lag behind this coordinate after it passes overhead moving toward the west.

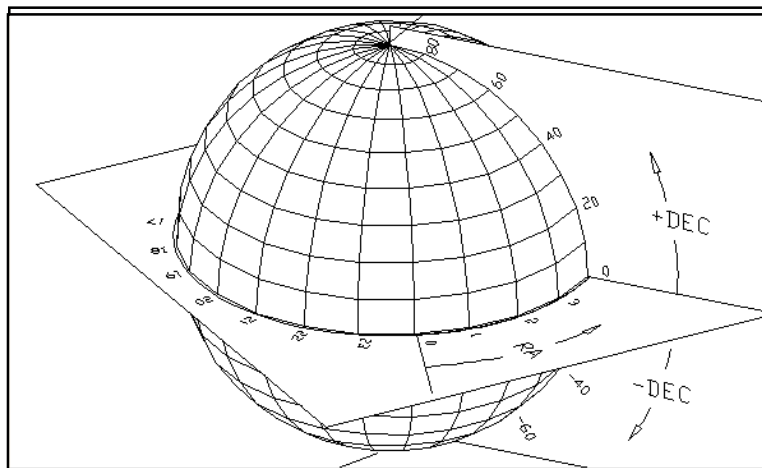

**Figure 6-1**  
The celestial sphere seen from the outside showing R.A. and DEC.

## Motion of the Stars

The daily motion of the Sun across the sky is familiar to even the most casual observer. This daily trek is not the Sun moving as early astronomers thought, but the result of the Earth's rotation. The Earth's rotation also causes the stars to do the same, scribing out a large circle as the Earth completes one rotation. The size of the circular path a star follows depends on where it is in the sky. Stars near the celestial equator form the largest circles rising in the east and setting in the west. Moving toward the north celestial pole, the point around which the stars in the northern hemisphere appear to rotate, these circles become smaller. Stars at high celestial latitudes are always above the horizon, and are said to be circumpolar because they never rise and never set. You will never see the stars complete one circle because the sunlight during the day washes out the starlight. However, part of this circular motion of stars in this region of the sky can be seen by setting up a camera on a tripod and opening the shutter for a couple hours. The processed film will reveal semicircles that revolve around the pole. (This description of stellar motions also applies to the southern hemisphere except all stars south of the celestial equator move around the south celestial pole.)

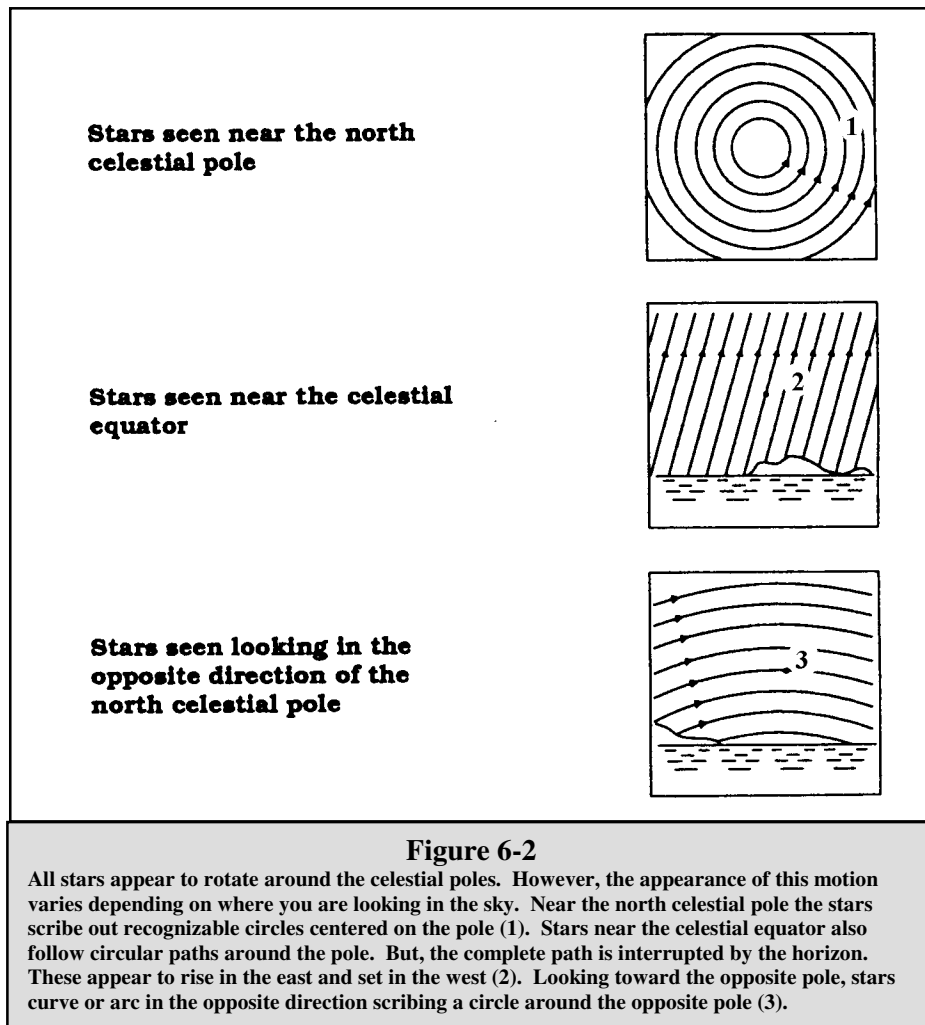

## Polar Alignment (with optional Wedge)

Even though the NexStar can precisely track a celestial object while in the Alt-Az position, it is still necessary to align the polar axis of the telescope (the fork arm) to the Earth's axis on rotation in order to do long exposure astro photography. To do an accurate polar alignment, the NexStar requires an optional equatorial wedge between the telescope and a tripod. This allows the telescope's tracking motors to rotate the telescope around the celestial pole, the same way as the stars. Without the equatorial wedge, you would notice the stars in the eyepiece would slowly rotate around the center of the field of view. Although this gradual rotation would go unnoticed when viewing with an eyepiece, it would be very noticeable on film.

Polar alignment is the process by which the telescope's axis of rotation (called the polar axis) is aligned (made parallel) with the Earth's axis of rotation. Once aligned, a telescope with a clock drive will track the stars as they move across the sky. The result is that objects observed through the telescope appear stationary (i.e., they will not drift out of the field of view). If not using the clock drive, all objects in the sky (day or night) will slowly drift out of the field. This motion is caused by the Earth's rotation.

To align your NexStar on an equatorial wedge, it will be necessary to use the 2-star alignment method. When asked to level the telescope tube, use the hand control arrows buttons to position the tube perpendicular (90°) to the fork arm. Then continue to follow the alignment procedure as described in the *Hand Control* section of this manual.

Whether you are using your NexStar in the Alt-Az configuration or polar aligned, it will be necessary to locate where north is and more specifically where the North Star is.

### Definition

*The polar axis is the axis around which the telescope rotates when moved in right ascension. This axis points the same direction even when the telescope moves in right ascension and declination.*

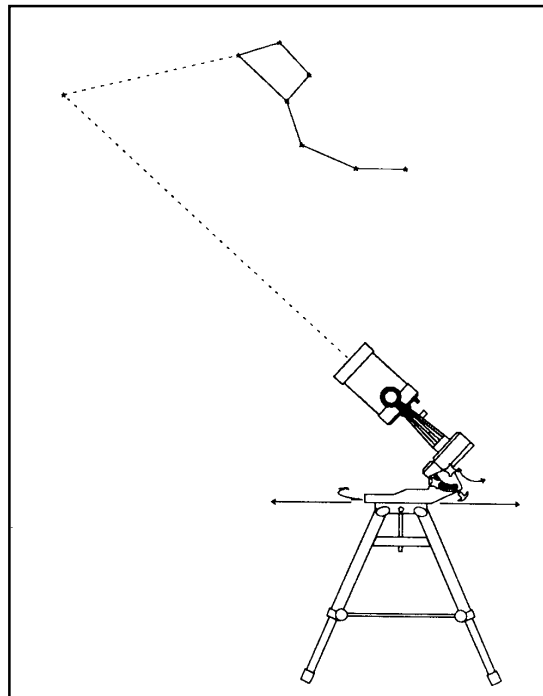
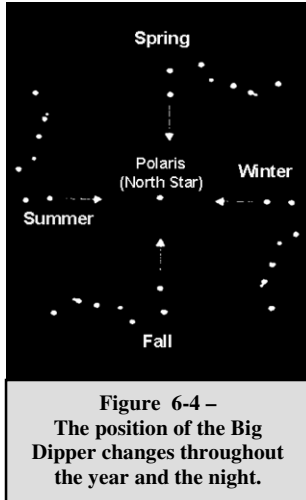

**Figure 6-3**

**This is how the telescope is to be set up for polar alignment. The tube should be parallel to the fork arm and the mount should point to Polaris.**

## Finding the North Celestial Pole

In each hemisphere, there is a point in the sky around which all the other stars appear to rotate. These points are called the celestial poles and are named for the hemisphere in which they reside. For example, in the northern hemisphere all stars move around the north celestial pole. When the telescope's polar axis is pointed at the celestial pole, it is parallel to the Earth's rotational axis.

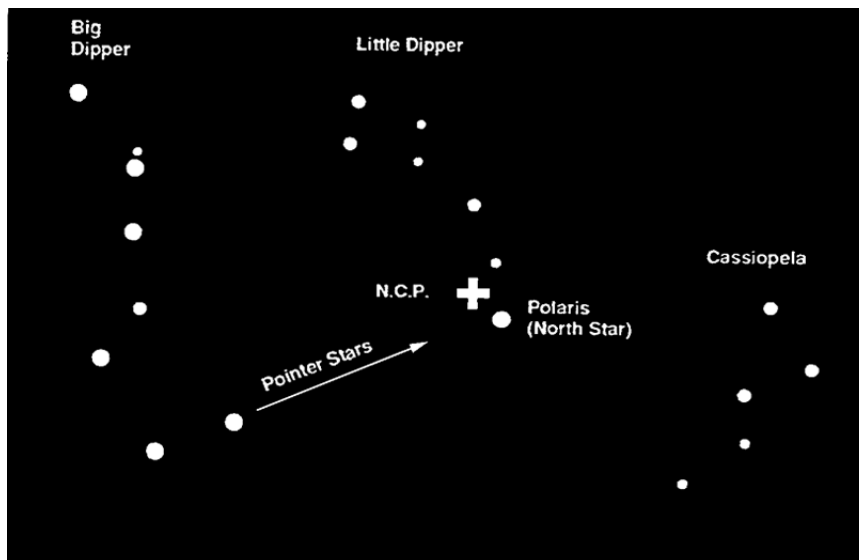

**Figure 6-4 –**  
The position of the Big Dipper changes throughout the year and the night.

Many methods of polar alignment require that you know how to find the celestial pole by identifying stars in the area. For those in the northern hemisphere, finding the celestial pole is not too difficult. Fortunately, we have a naked eye star less than a degree away. This star, Polaris, is the end star in the handle of the Little Dipper. Since the Little Dipper (technically called Ursa Minor) is not one of the brightest constellations in the sky, it may be difficult to locate from urban areas. If this is the case, use the two end stars in the bowl of the Big Dipper (the pointer stars). Draw an imaginary line through them toward the Little Dipper. They point to Polaris (see Figure 6-5). The position of the Big Dipper changes during the year and throughout the course of the night (see Figure 6-4). When the Big Dipper is low in the sky (i.e., near the horizon), it may be difficult to locate. During these times, look for Cassiopeia (see Figure 6-5). Observers in the southern hemisphere are not as fortunate as those in the northern hemisphere. The stars around the south celestial pole are not nearly as bright as those around the north. The closest star that is relatively bright is Sigma Octantis. This star is just within naked eye limit (magnitude 5.5) and lies about 59 arc minutes from the pole.

### Definition

*The north celestial pole is the point in the northern hemisphere around which all stars appear to rotate. The counterpart in the southern hemisphere is referred to as the south celestial pole.*

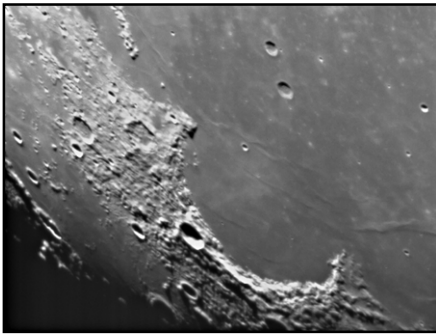

**Figure 6-5**  
The two stars in the front of the bowl of the Big Dipper point to Polaris which is less than one degree from the true (north) celestial pole. Cassiopeia, the “W” shaped constellation, is on the opposite side of the pole from the Big Dipper. The North Celestial Pole (N.C.P.) is marked by the “+” sign.

# CELESTRON Celestial Observing

With your telescope set up, you are ready to use it for observing. This section covers visual observing hints for both solar system and deep sky objects as well as general observing conditions which will affect your ability to observe.

## Observing the Moon



Often, it is tempting to look at the Moon when it is full. At this time, the face we see is fully illuminated and its light can be overpowering. In addition, little or no contrast can be seen during this phase.

One of the best times to observe the Moon is during its partial phases (around the time of first or third quarter). Long shadows reveal a great amount of detail on the lunar surface. At low power you will be able to see most of the lunar disk at one time. The optional Reducer/Corrector lens allows for breath-taking views of the entire lunar disk when used with a low power eyepiece. Change to higher power (magnification) to focus in on a smaller area. Choose the *lunar* tracking rate from the NexStar's MENU tracking rate options to keep the moon centered in the eyepiece even at high magnifications.

### Lunar Observing Hints

To increase contrast and bring out detail on the lunar surface, use filters. A yellow filter works well at improving contrast while a neutral density or polarizing filter will reduce overall surface brightness and glare.

## Observing the Planets

Other fascinating targets include the five naked eye planets. You can see Venus go through its lunar-like phases. Mars can reveal a host of surface detail and one, if not both, of its polar caps. You will be able to see the cloud belts of Jupiter and the great Red Spot (if it is visible at the time you are observing). In addition, you will also be able to see the moons of Jupiter as they orbit the giant planet. Saturn, with its beautiful rings, is easily visible at moderate power.

### Planetary Observing Hints

- Remember that atmospheric conditions are usually the limiting factor on how much planetary detail will be visible. So, avoid observing the planets when they are low on the horizon or when they are directly over a source of radiating heat, such as a rooftop or chimney. See the "Seeing Conditions" section later in this section.
- To increase contrast and bring out detail on the planetary surface, try using Celestron eyepiece filters.

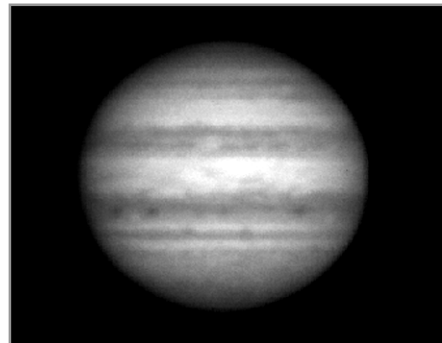

## ***Observing the Sun***

Although overlooked by many amateur astronomers, solar observation is both rewarding and fun. However, because the Sun is so bright, special precautions must be taken when observing our star so as not to damage your eyes or your telescope.

Never project an image of the Sun through the telescope. Because of the folded optical design, tremendous heat build-up will result inside the optical tube. This can damage the telescope and/or any accessories attached to the telescope.

For safe solar viewing, use a solar filter that reduces the intensity of the Sun's light, making it safe to view. With a filter you can see sunspots as they move across the solar disk and faculae, which are bright patches seen near the Sun's edge.

### **Solar Observing Hints**

- The best time to observe the Sun is in the early morning or late afternoon when the air is cooler.
- To center the Sun without looking into the eyepiece, watch the shadow of the telescope tube until it forms a circular shadow.
- To ensure accurate tracking, be sure to select solar tracking rate.

## ***Observing Deep Sky Objects***

Deep-sky objects are simply those objects outside the boundaries of our solar system. They include star clusters, planetary nebulae, diffuse nebulae, double stars and other galaxies outside our own Milky Way. Most deep-sky objects have a large angular size. Therefore, low-to-moderate power is all you need to see them. Visually, they are too faint to reveal any of the color seen in long exposure photographs. Instead, they appear black and white. And, because of their low surface brightness, they should be observed from a dark-sky location. Light pollution around large urban areas washes out most nebulae making them difficult, if not impossible, to observe. Light Pollution Reduction filters help reduce the background sky brightness, thus increasing contrast.

## ***Seeing Conditions***

Viewing conditions affect what you can see through your telescope during an observing session. Conditions include transparency, sky illumination, and seeing. Understanding viewing conditions and the effect they have on observing will help you get the most out of your telescope.

### ***Transparency***

Transparency is the clarity of the atmosphere which is affected by clouds, moisture, and other airborne particles. Thick cumulus clouds are completely opaque while cirrus can be thin, allowing the light from the brightest stars through. Hazy skies absorb more light than clear skies making fainter objects harder to see and reducing contrast on brighter objects. Aerosols ejected into the upper atmosphere from volcanic eruptions also affect transparency. Ideal conditions are when the night sky is inky black.

### ***Sky Illumination***

General sky brightening caused by the Moon, aurorae, natural airglow, and light pollution greatly affect transparency. While not a problem for the brighter stars and planets, bright skies reduce the contrast of extended nebulae making them difficult, if not impossible, to see. To maximize your observing, limit deep sky viewing to moonless nights far from the light polluted skies found around major urban areas. LPR filters enhance deep sky viewing from light polluted areas by blocking unwanted light while transmitting light from certain deep sky objects. You can, on the other hand, observe planets and stars from light polluted areas or when the Moon is out.

## Seeing

Seeing conditions refers to the stability of the atmosphere and directly affects the amount of fine detail seen in extended objects. The air in our atmosphere acts as a lens which bends and distorts incoming light rays. The amount of bending depends on air density. Varying temperature layers have different densities and, therefore, bend light differently. Light rays from the same object arrive slightly displaced creating an imperfect or smeared image. These atmospheric disturbances vary from time-to-time and place-to-place. The size of the air parcels compared to your aperture determines the "seeing" quality. Under good seeing conditions, fine detail is visible on the brighter planets like Jupiter and Mars, and stars are pinpoint images. Under poor seeing conditions, images are blurred and stars appear as blobs.

The conditions described here apply to both visual and photographic observations.

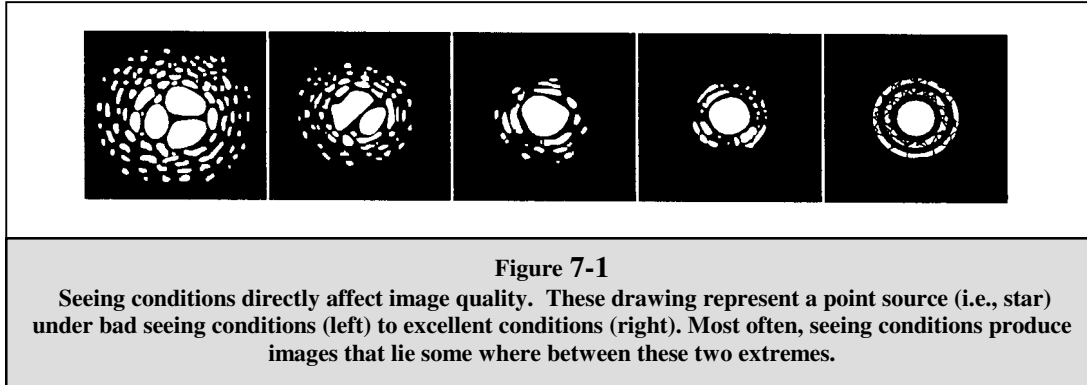



After looking at the night sky for a while you may want to try photographing it. Several forms of celestial photography are possible with your telescope, including short exposure prime focus, eyepiece projection, long exposure deep sky, terrestrial and even CCD imaging. Each of these is discussed in moderate detail with enough information to get you started. Topics include the accessories required and some simple techniques. More information is available in some of the publications listed at the end of this manual.

In addition to the specific accessories required for each type of celestial photography, there is the need for a camera - but not just any camera. The camera does not have to have many of the features offered on today's state-of-the-art equipment. For example, you don't need auto focus capability or mirror lock up. Here are the mandatory features a camera needs for celestial photography. First, a "B" setting which allows for time exposures. This excludes point and shoot cameras and limits the selection to SLR cameras, the most common type of 35mm camera on the market today.

Second, the "B" or manual setting should NOT run off the battery. Many new electronic cameras use the battery to keep the shutter open during time exposures. Once the batteries are drained, usually after a few minutes, the shutter closes, whether you were finished with the exposure or not. Look for a camera that has a manual shutter when operating in the time exposure mode. Olympus, Nikon, Minolta, Pentax, Canon and others have made such camera bodies.

The camera must have interchangeable lenses so you can attach it to the telescope and so you can use a variety of lenses for piggyback photography. If you can't find a new camera, you can purchase a used camera body that is not 100-percent functional. The light meter, for example, does not have to be operational since you will be determining the exposure length manually.

You also need a cable release with a locking function to hold the shutter open while you do other things. Mechanical and air release models are available.

## ***Short Exposure Prime Focus Photography***

Short exposure prime focus photography is the best way to begin recording celestial objects. It is done with the camera attached to the telescope without an eyepiece or camera lens in place. To attach your camera you need the Celestron T-Adapter (#93633-A) and a T-Ring for your specific camera (i.e., Minolta, Nikon, Pentax, etc.). The T-Ring replaces the 35mm SLR camera's normal lens. Prime focus photography allows you to capture the majority of the lunar disk or solar disk. To attach your camera to your telescope.

1. Remove all visual accessories.
2. Thread the T-Ring onto the T-Adapter.
3. Mount your camera body onto the T-Ring the same as you would any other lens.
4. Thread the T-Adapter onto the back of the telescope while holding the camera in the desired orientation (either vertical or horizontal).

With your camera attached to the telescope, you are ready for prime focus photography. Start with an easy object like the Moon. Here's how to do it:

1. Load your camera with film that has a moderate-to-fast speed (i.e., ISO rating). Faster films are more desirable when the Moon is a crescent. When the Moon is near full, and at its brightest, slower films are more desirable. Here are some film recommendations:



- T-Max 100
  - T-Max 400
  - Any 100 to 400 ISO color slide film
  - Fuji Super HG 400
  - Ektar 25 or 100
1. Center the Moon in the field of your NexStar telescope.
  2. Focus the telescope by turning the focus knob until the image is sharp.
  3. Set the shutter speed to the appropriate setting (see table below).
  4. Trip the shutter using a cable release.
  5. Advance the film and repeat the process.

Lunar Phase	ISO 50	ISO 100	ISO 200	ISO 400
Crescent	1/2	1/4	1/8	1/15
Quarter	1/15	1/30	1/60	1/125
Full	1/30	1/60	1/125	1/250

**Table 8-1**  
Above is a listing of recommended exposure times when photographing the Moon at the prime focus of your NexStar telescope.

The exposure times listed in table 8-1 should be used as a starting point. Always make exposures that are longer and shorter than the recommended time. Also, take a few photos at each shutter speed. This will ensure that you will get a good photo.

If using black and white film, try a yellow filter to reduce the light intensity and to increase contrast.

Keep accurate records of your exposures. This information is useful if you want to repeat your results or if you want to submit some of your photos to various astronomy magazines for possible publication!

This technique is also used for photographing the Sun with the proper solar filter.

## Eyepiece Projection

This form of celestial photography is designed for objects with small angular sizes, primarily the Moon and planets. Planets, although physically quite large, appear small in angular size because of their great distances. Moderate to high magnification is, therefore, required to make the image large enough to see any detail. Unfortunately, the camera/telescope combination alone does not provide enough magnification to produce a usable image size on film. In order to get the image large enough, you must attach your camera to the telescope with the eyepiece in place. To do so, you need two additional accessories; a deluxe tele-extender (#93643), which attaches to the visual back, and a T-ring for your particular camera make (i.e., Minolta, Nikon, Pentax, etc.).

Because of the high magnifications during eyepiece projection, the field of view is quite small which makes it difficult to find and center objects. To make the job a little easier, align the finder as accurately as possible. This allows you to get the object in the telescope's field based on the finder's view alone.

Another problem introduced by the high magnification is vibration. Simply tripping the shutter — even with a cable release — produces enough vibration to smear the image. To get around this, use the camera's self-timer if the exposure time is less than one second — a common occurrence when photographing the Moon. For exposures over one second, use the "hat trick." This technique incorporates a hand-held black card placed over the aperture of the telescope to act as a shutter. The card prevents light from entering the telescope while the shutter is released. Once the shutter has been released and the vibration has diminished (a few seconds), move the black card out of the way to expose the film. After the exposure is complete, place the card over the front of the telescope and close the shutter. Advance the film and you're ready for your next shot. Keep in mind that the card should be held a few inches in front of the telescope, and not touching it. It is easier if you use two people for this process; one to release the camera shutter and one to hold the card. Here's the process for making the exposure.

1. Find and center the desired target in the viewfinder of your camera.
2. Turn the focus knob until the image is as sharp as possible.
3. Place the black card over the front of the telescope.
4. Release the shutter using a cable release.
5. Wait for the vibration caused by releasing the shutter to diminish. Also, wait for a moment of good seeing.
6. Remove the black card from in front of the telescope for the duration of the exposure (see accompanying table).
7. Replace the black card over the front of the telescope.
8. Close the camera's shutter.

Advance the film and you are ready for your next exposure. Don't forget to take photos of varying duration and keep accurate records of what you have done. Record the date, telescope, exposure duration, eyepiece, f/ratio, film, and some comments on the seeing conditions.

The following table lists exposures for eyepiece projection with a 10mm eyepiece. All exposure times are listed in seconds or fractions of a second.

Planet	ISO 50	ISO 100	ISO 200	ISO 400
Moon	4	2	1	1/2
Mercury	16	8	4	2
Venus	1/2	1/4	1/8	1/15
Mars	16	8	4	2
Jupiter	8	4	2	1
Saturn	16	8	4	2

**Table 8-2**  
**Recommended exposure time for photographing planets.**

The exposure times listed here should be used as a starting point. Always make exposures that are longer and shorter than the recommended time. Also, take a few photos at each shutter speed. This will ensure that you get a good photo. It is not uncommon to go through an entire roll of 36 exposures and have only one good shot.

**NOTE:** Don't expect to record more detail than you can see visually in the eyepiece at the time you are photographing.

Once you have mastered the technique, experiment with different films, different focal length eyepieces, and even different filters.

## ***Long Exposure Prime Focus Photography***

This is the last form of celestial photography to be attempted after others have been mastered. It is intended primarily for deep sky objects, that is objects outside our solar system which includes star clusters, nebulae, and galaxies. While it may seem that high magnification is required for these objects, just the opposite is true. Most of these objects cover large angular areas and fit nicely into the prime focus field of your telescope. The brightness of these objects, however, requires long exposure times and, as a result, are rather difficult.

There are several techniques for this type of photography, and the one chosen will determine the standard accessories needed. The best method for long exposure deep sky astro photography is with an off-axis guider. This device allows you to photograph and guide through the telescope simultaneously. Celestron offers a very special and advanced off-axis guider, called the Radial Guider (#94176). In addition, you will need a T-Ring to attach your camera to the Radial Guider.

Other equipment needs include a guiding eyepiece. Unlike other forms of astro photography which allows for fairly loose guiding, prime focus requires meticulous guiding for long periods. To accomplish this you need a guiding ocular

with an illuminated reticle to monitor your guide star. For this purpose, Celestron offers the Micro Guide Eyepiece (#94171) Here is a brief summary of the technique.

1. Polar align the telescope using an optional equatorial wedge.
2. Remove all visual accessories.
3. Thread the Radial Guider onto your telescope.
4. Thread the T-Ring onto the Radial Guider.
5. Mount your camera body onto the T-Ring the same as you would any other lens.
6. Set the shutter speed to the "B" setting.
7. Focus the telescope on a star.
8. Center your subject in the field of your camera.
9. Find a suitable guide star in the telescope field. This can be the most time consuming process.
10. Open the shutter using a cable release.
11. Monitor your guide star for the duration of the exposure using the buttons on the hand controller to make the needed corrections.
12. Close the camera's shutter.

When getting started, use fast films to record as much detail in the shortest possible time. Here are proven recommendations:

- Ektar 1000 (color print)
- Konica 3200 (color print)
- Fujichrome 1600D (color slide)
- 3M 1000 (color slide)
- Scotchchrome 400
- T-Max 3200 (black and white print)
- T-Max 400 (black and white print)

As you perfect your technique, try specialized films, that is films that are designed or specially treated for celestial photography. Here are some popular choices:

- Ektar 125 (color print)
- Fujichrome 100D (color slide)
- Tech Pan, gas hypered (black and white print)
- T-Max 400 (black and white print)

There is no exposure determination table to help you get started. The best way to determine exposure length is look at previously published photos to see what film/exposure combinations were used. Or take unguided sample photos of various parts of the sky while the drive is running. Always take exposures of various lengths to determine the best exposure time.

## ***Terrestrial Photography***

Your NexStar makes an excellent 2000mm telephoto lens for terrestrial (land) photography. Terrestrial photography is best done with the telescope in Alt-Az configuration and the tracking drive turned off. To turn the tracking drive off, press the MENU (9) button on the hand control and scroll down to the Tracking Mode sub menu. Use the Up and Down scroll keys (10) to select the Off option and press ENTER. This will turn the tracking motors off, so that objects will remain in your camera's field of view.

## **Metering**

The NexStar has a fixed aperture and, as a result, fixed f/ratios. To properly expose your subjects photographically, you need to set your shutter speed accordingly. Most 35mm SLR cameras offer through-the-lens metering which lets you know if your picture is under or overexposed. Adjustments for proper exposures are made by changing the shutter speed. Consult your camera manual for specific information on metering and changing shutter speeds.

## **Reducing Vibration**

Releasing the shutter manually can cause vibrations, producing blurred photos. To reduce vibration when tripping the shutter, use a cable release. A cable release keeps your hands clear of the camera and lens, thus eliminating the possibility of introducing vibration. Mechanical shutter releases can be used, though air-type releases are best. Blurry pictures can also result from shutter speeds that are too slow. To prevent this, use films that produce shutter speeds greater than 1/250 of a second when hand-holding the lens. If the lens is mounted on a tripod, the exposure length is virtually unlimited.

Another way to reduce vibration is with the Vibration Suppression Pads (#93503). These pads rest between the ground and tripod feet. They reduce the vibration amplitude and vibration time.

## **CCD Imaging**

CCD Imaging is the most challenging form of astro photography and involves the use of a CCD (Charged Coupled Device) camera attached to the telescope at prime focus. The benefits of CCD imaging is the extreme light sensitivity of the electronic chip inside the camera. This allows you to record much fainter detail in a shorter period of time than would be possible with film photography. Due to the relative small size of the CCD chip, the field of view when imaging will be less than the field of view of a film camera. Using Celestron's optional f/6.3 Reducer/Corrector accessory in conjunction with a CCD camera (or film camera) will greatly increase the photographic field of view and will make finding and tracking a celestial object much easier.

# CELESTRON® **Telescope Maintenance**

While your NexStar telescope requires little maintenance, there are a few things to remember that will ensure your telescope performs at its best.

## **Care and Cleaning of the Optics**

Occasionally, dust and/or moisture may build up on the corrector plate of your telescope. Special care should be taken when cleaning any instrument so as not to damage the optics.

If dust has built up on the corrector plate, remove it with a brush (made of camel's hair) or a can of pressurized air. Spray at an angle to the lens for approximately two to four seconds. Then, use an optical cleaning solution and white tissue paper to remove any remaining debris. Apply the solution to the tissue and then apply the tissue paper to the lens. Low pressure strokes should go from the center of the corrector to the outer portion. **Do NOT rub in circles!**

You can use a commercially made lens cleaner or mix your own. A good cleaning solution is isopropyl alcohol mixed with distilled water. The solution should be 60% isopropyl alcohol and 40% distilled water. Or, liquid dish soap diluted with water (a couple of drops per one quart of water) can be used.

Occasionally, you may experience dew build-up on the corrector plate of your telescope during an observing session. If you want to continue observing, the dew must be removed, either with a hair dryer (on low setting) or by pointing the telescope at the ground until the dew has evaporated.

If moisture condenses on the inside of the corrector, remove the accessories from the rear cell of the telescope. Place the telescope in a dust-free environment and point it down. This will remove the moisture from the telescope tube.

To minimize the need to clean your telescope, replace all lens covers once you have finished using it. Since the rear cell is NOT sealed, the cover should be placed over the opening when not in use. This will prevent contaminants from entering the optical tube.

Internal adjustments and cleaning should be done only by the Celestron repair department. If your telescope is in need of internal cleaning, please call the factory for a return authorization number and price quote.



**Figure 9-1**  
The three collimation screws are located on the secondary mirror holder in the center of the corrector plate.

## **Collimation**

The optical performance of your NexStar telescope is directly related to its collimation, that is the alignment of its optical system. Your NexStar was collimated at the factory after it was completely assembled. However, if the telescope is dropped or jarred severely during transport, it may have to be collimated. The only optical element that may need to be adjusted, or is possible, is the tilt of the secondary mirror.

To check the collimation of your telescope you will need a light source. A bright star near the zenith is ideal since there is a minimal amount of atmospheric distortion. Make sure that tracking is on so that you won't have to manually track the star. Or, if you do not want to power up your telescope, you can use Polaris. Its position relative to the celestial pole means that it moves very little thus eliminating the need to manually track it.

Before you begin the collimation process, be sure that your telescope is in thermal equilibrium with the surroundings. Allow 45 minutes for the telescope to reach equilibrium if you move it between large temperature extremes.

To verify collimation, view a star near the zenith. Use a medium to high power ocular — 12mm to 6mm focal length. It is important to center a star in the center of the field to judge collimation. Slowly cross in and out of focus and judge the symmetry of the star. If you see a systematic skewing of the star to one side, then recollimation is needed.

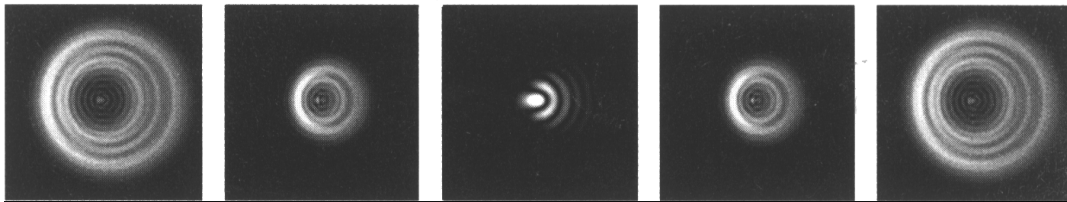
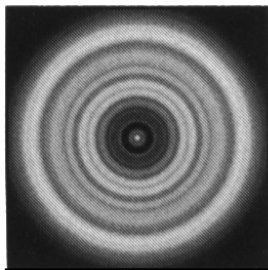

**Figure 9-2 -- Even though the star pattern appears the same on both sides of focus, they are asymmetric. The dark obstruction is skewed off to the left side of the diffraction pattern indicating poor collimation.**

To accomplish this, you need to tighten the secondary collimation screw(s) that move the star across the field toward the direction of the skewed light. These screws are located in the secondary mirror holder (see figure 9-1). To access the collimation screws you will need to remove the cap that covers the secondary mirror holder. To remove the cap, gently slide a flat head screw driver underneath one end of the cap and twist the screw driver. Slide the screw driver underneath the other side of the cap and twist until the cap comes off. Make only a small 1/6 to 1/8 adjustments to the collimation screws and re-center the star by moving the scope before making any improvements or before making further adjustments.

To make collimation a simple procedure, follow these easy steps:

1. While looking through a medium to high power eyepiece, de-focus a bright star until a ring pattern with a dark shadow appears (see figure 9-2). Center the de-focused star and notice in which direction the central shadow is skewed.
2. Place your finger along the edge of the front cell of the telescope (be careful not to touch the corrector plate), pointing towards the collimation screws. The shadow of your finger should be visible when looking into the eyepiece. Rotate your finger around the tube edge until its shadow is seen closest to the narrowest portion of the rings (i.e. the same direction in which the central shadow is skewed).
3. Locate the collimation screw closest to where your finger is positioned. This will be the collimation screw you will need to adjust first. (If your finger is positioned exactly between two of the collimation screws, then you will need to adjust the screw opposite where your finger is located).
4. Use the hand control buttons to move the de-focused star image to the edge of the field of view, in the same direction that the central obstruction of the star image is skewed.
5. While looking through the eyepiece, use an Allen wrench to turn the collimation screw you located in step 2 and 3. Usually a tenth of a turn is enough to notice a change in collimation. If the star image moves out of the field of view in the direction that the central shadow is skewed, than you are turning the collimation screw the wrong way. Turn the screw in the opposite direction, so that the star image is moving towards the center of the field of view.
6. If while turning you notice that the screws get very loose, then simply tighten the other two screws by the same amount. Conversely, if the collimation screw gets too tight, then loosen the other two screws by the same amount.
7. Once the star image is in the center of the field of view, check to see if the rings are concentric. If the central obstruction is still skewed in the same direction, then continue turning the screw(s) in the same direction. If you find that the ring pattern is skewed in a different direction, than simply repeat steps 2 through 6 as described above for the new direction.



**Figure 9-3  
A collimated telescope should appear symmetrical with the central obstruction centered in the star's diffraction pattern.**

Perfect collimation will yield a star image very symmetrical just inside and outside of focus. In addition, perfect collimation delivers the optimal optical performance specifications that your telescope is built to achieve.

If seeing (i.e., air steadiness) is turbulent, collimation is difficult to judge. Wait until a better night if it is turbulent or aim to a steadier part of the sky. A steadier part of the sky is judged by steady versus twinkling stars.



CELESTRON®

## Optional Accessories

You will find that additional accessories enhance your viewing pleasure and expand the usefulness of your telescope. For ease of reference, all the accessories are listed in alphabetical order.

### Adapter, Car Battery (#18769) -



Celestron offers the Car Battery Adapter that allows you to run the NexStar drive off an external power source. The adapter attaches to the cigarette lighter of your car, truck, van, or motorcycle.

**Barlow Lens** - A Barlow lens is a negative lens that increases the focal length of a telescope. Used with any eyepiece, it doubles the magnification of that eyepiece. Celestron offers two Barlow lens in the 1-1/4" size for the NexStar. The 2x Ultima Barlow (#93506) is a compact triplet design that is fully multicoated for maximum light transmission and parfocal when used with the Ultima eyepieces. Model #93507 is a compact achromatic Barlow lens that is under three inches long and weighs only 4 oz. It works very well with all Celestron eyepieces.

**Carrying Case (#302070)** - This rugged case is constructed of space age resin, making it waterproof, unbreakable, airtight and extremely durable. It's designed so your telescope can be packed with the standard finderscope in place, a convenience you'll be sure to appreciate. The case is lined with die cut foam for custom fitting. It features large handles and is equipped with wheels, for easy transportation. Weight: 17 lbs. (31.5"x 21.75"x 11.5").

**CD-ROM (#93700)** - Celestron and Software Bisque have joined together to present this comprehensive CD-ROM called *The Sky™ Level 1 - from Celestron*. It features a 10,000 object database, 75 color images, horizontal projection, custom sky chart printing, zoom capability and more! A fun, useful and educational product. PC format.



**Erect Image Diagonal (#94112-A)** - This accessory is an Amici prism arrangement that allows you to look into the telescope at a 45° angle with images that are oriented properly (upright and correct from left-to-right). It is useful for daytime, terrestrial viewing.

**Eyepieces** - Like telescopes, eyepieces come in a variety of designs. Each design has its own advantages and disadvantages. For the 1-1/4" barrel diameter there are four different eyepiece designs available.

- **Super Modified Achromatic (SMA) Eyepieces: 1 1/4"**

The SMA design is an improved version of the Kellner eyepiece. SMAs are very good, economical, general purpose eyepieces that deliver a wide apparent field, good color correction and an excellent image at the center of the field of view. Celestron offers SMA eyepieces in 1-1/4" sizes in the following focal lengths: 6mm, 10mm, 12mm, 17mm and 25mm.

- **Ultima** - Ultima is not really a design, but a trade name for our 5-element, wide field eyepieces. In the 1-1/4" barrel diameter, they are available in the following focal lengths: 5mm, 7.5mm, 12.5mm, 18mm, 24mm, 30mm, 35mm, and 42mm. These eyepieces are all parfocal. The 35mm Ultima gives the widest possible field of view with a 1-1/4" diagonal and is ideal for the NexStar with or without the Reducer/Corrector.

- **NexStar Plössl** - Plössl eyepieces have a 4-element lens designed for low-to-high power observing. The Plössls offer razor sharp views across the entire field, even at the edges! In the 1-1/4" barrel diameter, they are available in the following focal lengths: 3.6mm, 6mm, 8mm, 10mm, 13mm, 17mm, 25mm, 32mm and 40mm.

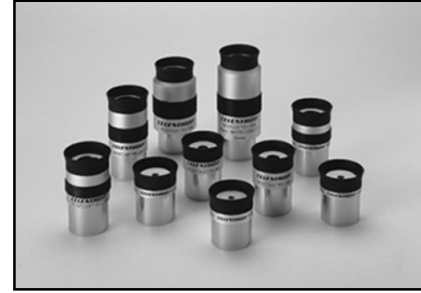

- **Lanthanum Eyepieces (LV Series)** - Lanthanum is a unique rare earth glass used in one of the field lenses of this new eyepiece. The Lanthanum glass reduces aberrations to a minimum. All are fully multicoated and have an astounding 20mm of eye relief — perfect for eyeglass wearers! In the 1-1/4" barrel diameter, they are available in the following focal lengths: 2.5mm, 4mm, 5mm, 6mm, 9mm, 10mm, 12mm and 15mm. Celestron also offers the LV Zoom eyepiece (#3777) with a focal length of 8mm to 24mm. It offers an apparent field of 40° at 24mm and 60° at 8mm. Eye relief ranges from 15mm to 19mm.

**Eyepiece Filters** - To enhance your visual observations of solar system objects, Celestron offers a wide range of colored filters that thread into the 1-1/4" oculars. Available individually are: #12 deep yellow, #21 orange, #25 red, #58 green, #80A light blue, #96 neutral density - 25%T, #96 neutral density - 13%T, and polarizing. These and other filters are also sold in sets.



**Night Vision Flashlight - (#93588)** - Celestron's premium model for astronomy, using two red LEDs to preserve night vision better than red filters or other devices. Brightness is adjustable. Operates on a single 9 volt battery (included).

**Red Astro Lite - (#93590)** - An economical squeeze-type flashlight fitted with a red cap to help preserve your night vision. Remove the red cap for normal flashlight operation. Very compact size and handy keychain.

**Light Pollution Reduction (LPR) Filters** - These filters are designed to enhance your views of deep sky astronomical objects when viewed from urban areas. LPR Filters selectively reduce the transmission of certain wavelengths of light,

specifically those produced by artificial lights. This includes mercury and high and low pressure sodium vapor lights. In addition, they also block unwanted natural light (sky glow) caused by neutral oxygen emission in our atmosphere. Celestron offers a model for 1-1/4" eyepieces (#94126A) and a model that attaches to the rear cell ahead of the star diagonal and visual back (#94127A).

**Micro Guide Eyepiece (#94171)** - This multipurpose 12.5mm illuminated reticle can be used for guiding deep-sky astrophotos, measuring position angles, angular separations, and more. The laser etched reticle provides razor sharp lines and the variable brightness illuminator is completely cordless. The micro guide eyepiece produces 100 power when used with the NexStar at f/10.

**Moon Filters (#94119-A)** - Celestron's Moon Filters is an economical eyepiece filter for reducing the brightness of the moon and improving contrast, so greater detail can be observed on the lunar surface. The clear aperture is 21mm and the transmission is about 18%.

**Planisphere (#93720)** - A simple and inexpensive tool for all levels of observers, from naked eye viewers to users of highly sophisticated telescopes. The Celestron Planisphere makes it easy to locate stars for observing and is a great planet finder as well. A map of the night sky, oriented by month and day, rotates within a depiction of the 24 hours of the day, to display exactly which stars and planets will be visible at any given time. Ingeniously simple to use, yet quite effective. Made of durable materials and coated for added protection. Celestron Planispheres come in three different models, to match the latitude from which you're observing:

For 20° to 40° of latitude	#93720-30
For 30° to 50° of latitude	#93720-40
For 40° to 60° of latitude	#93720-50

**Polarizing Filter Set (#93608)** - The polarizing filter set limits the transmission of light to a specific plane, thus increasing contrast between various objects. This is used primarily for terrestrial, lunar and planetary observing.



**Radial Guider (#94176)** - The Celestron Radial Guider® is specifically designed for use in prime focus, deep sky stro photography and takes the place of the T-Adapter. This device allows you to photograph and guide simultaneously through the optical tube assembly of your telescope. This type of guiding produces the best results since what you see through the guiding eyepiece is exactly reproduced on the processed film. The Radial Guider is a “T”-shaped assembly that attaches to the rear cell of the telescope. As light from the telescope enters the guider, most passes straight through to the camera. A small portion, however, is diverted by a prism at an adjustable angle up to the guiding eyepiece. This guider has two features not found on other off-axis guiders; first, the prism and eyepiece housing rotate independently of the camera orientation making the acquisition of a guide star quite easy. Second, the prism angle is tunable allowing you to look at guide stars on-axis. This accessory works especially well with the Reducer/Corrector.



**Reducer/Corrector (#94175)** - This lens reduces the focal length of the telescope by 37%, making your NexStar a 787.5mm f/6.3 instrument. In addition, this unique lens also corrects inherent aberrations to produce crisp images all the way across the field when used visually. When used photographically, there is some vignetting that produces a 26mm circular image on the processed film. It also increases the field of view significantly and is ideal for wide-field, deep-space viewing. It is also perfect for beginning prime focus, long-exposure astro photography when used with the radial guider. It makes guiding easier and exposures much shorter.

**Sky Maps (#93722)** - Celestron Sky Maps are the ideal teaching guide for learning the night sky. You wouldn't set off on a road trip without a road map, and you don't need to try to navigate the night sky without a map either. Even if you already know your way around the major constellations, these maps can help you locate all kinds of fascinating objects.

**Skylight Filter (#93621)** - The Skylight Filter is used on the Celestron NexStar telescope as a dust seal. The filter threads onto the rear cell of your telescope. All other accessories, both visual and photographic (with the exception of Barlow lenses), thread onto the skylight filter. The light loss caused by this filter is minimal.

**Solar Filter (#94162)** - The AstroSolar® filter is a safe and durable filter that covers the front opening of the telescope. View sunspots and other solar features using this double-sided metal coated filter for uniform density and good color balance across the entire field. The Sun offers constant changes and will keep your observing interesting and fun.

**T-Adapter (#93633-A)** - T-Adapter (with additional T-Ring) allows you to attach your SLR camera to the rear cell of your Celestron NexStar. This turns your NexStar into a 2000mm telephoto lens perfect for terrestrial photography and short exposure lunar and filtered solar photography.

**T-Ring** - The T-Ring couples your 35mm SLR camera body to the T-Adapter, radial guider, or tele-extender. This accessory is mandatory if you want to do photography through the telescope. Each camera make (i.e., Minolta, Nikon, Pentax, etc.) has its own unique mount and therefore, its own T-Ring. Celestron has 8 different models for 35mm cameras.



**Tele-Extender, Deluxe (#93643)** - The tele-extender is a hollow tube that allows you to attach a camera to the telescope when the eyepiece is installed. This accessory is used for eyepiece projection photography which allows you to capture very high power views of the Sun, Moon, and planets on film. The tele-extender fits over the eyepiece onto the visual back. This tele-extender works with eyepieces that have large housings, like the Celestron Ultima series.

**Vibration Suppression Pads (#93503)** - These pads rest between the ground and tripod feet of your telescope. They reduce the amplitude and vibration time of your telescope when shaken by the wind or an accidental bump. This accessory is a must for long exposure prime focus photography.

**Wedge, NexStar** – The wedge allows you to tilt the telescope so that its polar axis is parallel to the earth's axis of rotation. Ideal for using your NexStar for guided astro photography.

**A full description of all Celestron accessories can be found in the Celestron Accessory Catalog (#93685).**

## Appendix A - Technical Specifications

### Optical Specification

Design	Schmidt-Cassegrain Catadioptric
Aperture	8 inches (203.2mm)
Focal Length	80 inches (2032mm)
F/ratio of the Optical System	10
Primary Mirror: Material Coatings	Fine Annealed Pyrex Starbright Coatings - 5 step multilayer process
Secondary Mirror: Material Coatings	Hand Figured Fine Annealed Pyrex Starbright Coatings - 5 step multilayer process
Central Obstruction	2.75"
Corrector Plate: Material Coatings	Optical Quality Crown Glass A-R Coatings both sides
Highest Useful Magnification	480x (~ 4mm eyepiece)
Lowest Useful Magnification (7mm exit pupil)	29x (~ 70mm eyepiece) (~ 44mm eyepiece with optional Reducer Corrector)
Resolution: Rayleigh Criterion Dawes Limit	.68 arc seconds .57arc seconds
Photographic Resolution	182 lines/mm
Light Gathering Power	843x unaided eye
Near Focus standard eyepiece or camera	~ 25 feet
Field of View: Standard Eyepiece : 35mm Camera	.92° 1.0° x .68° (1.6° x 1.07° - with optional Reducer Corrector)
Linear Field of View (at 1000 yds)	54 feet
Magnification: Standard Eyepiece : Camera	50x 25x
Optical Tube Length	16 inches
Weight of Telescope	24 Lbs.

### Electronic Specifications

Input Voltage Maximum Minimum	12 V DC Nominal 18 V DC Max. 8 V DC Min.
Batteries Required	8 AA Alkaline
Power Supply Requirements	12 VDC-750 mA (Tip positive)

### Mechanical Specifications

Motor: Type Resolution	DC Servo motors with encoders, both axes .26 arc sec
Slew speeds	Nine slew speeds: 6.5°/sec, 3°/sec, 1.5°/sec, 128x, 64x, 16x, 8x, 2x, 1x
Hand Control	Double line, 16 character Liquid Crystal Display 19 fiber optic backlit LED buttons
Fork Arm	Cast aluminum, with integrated hand control receptacle

### Software Specifications

Software Precision	16 bit, 20 arc sec. calculations
Ports	RS-232 communication port on hand control
Tracking Rates	Sidereal, Solar, Lunar and King
Tracking Modes	Alt-Az, EQ North & EQ South
Alignment Procedures	2-Star Alignment, AutoAlign
Database	18,000+ objects 25 user defined programmable objects. 9 user defined programmable longitudes and latitudes. Enhanced information on over 100 objects
Complete Revised NGC Catalog	7,840
Complete Messier Catalog	110
Complete Caldwell	109
Solar System objects	9
Famous Asterisms	20
Selected SAO Stars	10,385
<b>Total Object Database</b>	<b>18,473</b>

## Appendix B – Glossary of Terms

### A-

Absolute magnitude	The apparent magnitude that a star would have if it were observed from a standard distance of 10 parsecs, or 32.6 light-years. The absolute magnitude of the Sun is 4.8. at a distance of 10 parsecs, it would just be visible on Earth on a clear moonless night away from surface light.
Airy disk	The apparent size of a star's disk produced even by a perfect optical system. Since the star can never be focused perfectly, 84 per cent of the light will concentrate into a single disk, and 16 per cent into a system of surrounding rings.
Alt-Azimuth Mounting	A telescope mounting using two independent rotation axis allowing movement of the instrument in Altitude and Azimuth.
Altitude	In astronomy, the altitude of a celestial object is its Angular Distance above or below the celestial horizon.
Altitude	In astronomy, the altitude of a celestial object is its Angular Distance above or below the celestial horizon.
Aperture	the diameter of a telescope's primary lens or mirror; the larger the aperture, the greater the telescope's light-gathering power.
Apparent Magnitude	A measure of the relative brightness of a star or other celestial object as perceived by an observer on Earth.
Arcminute	A unit of angular size equal to 1/60 of a degree.
Arcsecond	A unit of angular size equal to 1/3,600 of a degree (or 1/60 of an arcminute).
Asterism	A small unofficial grouping of stars in the night sky.
Asteroid	A small, rocky body that orbits a star.
Astrology	the pseudoscientific belief that the positions of stars and planets exert an influence on human affairs; astrology has nothing in common with astronomy
Astronomical unit	The distance between the Earth and the Sun. It is equal to 149,597,900 km., usually rounded off to 150,000,000 km.
Aurora	the emission of light when charged particles from the solar wind slam into and excite atoms and molecules in a planet's upper atmosphere.
Azimuth	The angular distance of an object eastwards along the horizon, measured from due north, between the astronomical meridian (the vertical line passing through the centre of the sky and the north and south points on the horizon) and the vertical line containing the celestial body whose position is to be measured. .

### B -

Binary Stars	Binary stars are pairs of stars that, because of their mutual gravitational attraction, orbit around a common Centre of Mass. If a group of three or more stars revolve around one another, it is called a multiple system. It is believed that approximately 50 percent of all stars belong to binary or multiple systems. Systems with individual components that can be seen separately by telescope are called visual binaries or visual multiples. The nearest "star" to our solar system, Alpha Centauri, is actually our nearest example of a multiple star system, it consists of three stars two very similar to our Sun and one dim, small, red star orbiting around one another.
--------------	---

### C -

Celestial Equator	The projection of the Earth's equator on to the celestial sphere. It divides the sky into two equal hemispheres.
Celestial pole	the imaginary projection of Earth's rotational axis north or south pole onto the celestial sphere.
Celestial Sphere	An imaginary sphere surrounding the Earth, concentric with the Earth's center.
Collimation	the act of putting a telescope's optics into perfect alignment.

### D -

Declination	The angular distance of a celestial body north or south of the celestial equator. It may be said to correspond to latitude on the surface of the Earth.
-------------	---

### E -

Ecliptic	The projection of the Earth's orbit on to the celestial sphere. It may also be defined as "the apparent yearly path of the Sun against the stars".
Equatorial mount	A telescope mounting in which the instrument is set upon an axis which is parallel to the axis of the Earth; the angle of the axis must be equal to the observer's latitude.

### F -

Focal length	The distance between a lens (or mirror) and the point at which the image of an object at infinity is brought to focus. The focal length divided by the aperture of the mirror or lens is termed the focal ratio.
--------------	--

### J -

Jovian Planets	Any of the four gas giant planets that are at a greater distance from the sun than the terrestrial planets.
----------------	---

K - Kuiper Belt	A region beyond the orbit of Neptune extending to about 1000 AU which is a source of many short period comets.
L - Light-Year	A light-year is the distance light traverses in a vacuum in one year at the speed of 299,792 km/ sec. With 31,557,600 seconds in a year, the light-year equals a distance of 9.46 X 1 trillion km (5.87 X 1 trillion mi).
M - Magnitude	Magnitude is a measure of the brightness of a celestial body. The brightest stars are assigned magnitude 1 and those increasingly fainter from 2 down to magnitude 5. The faintest star that can be seen without a telescope is about magnitude 6. Each magnitude step corresponds to a ratio of 2.5 in brightness. Thus a star of magnitude 1 is 2.5 times brighter than a star of magnitude 2, and 100 times brighter than a magnitude 5 star. The brightest star, Sirius, has an apparent magnitude of -1.6, the full moon is -12.7, and the Sun's brightness, expressed on a magnitude scale, is -26.78. The zero point of the apparent magnitude scale is arbitrary.
Meridian	A reference line in the sky that starts at the North celestial pole and ends at the South celestial pole and passes through the zenith. If you are facing South, the meridian starts from your Southern horizon and passes directly overhead to the North celestial pole.
Messier	A French astronomer in the late 1700's who was primarily looking for comets. Comets are hazy diffuse objects and so Messier cataloged objects that were not comets to help his search. This catalog became the Messier Catalog, M1 through M110.
N - Nebula	Interstellar cloud of gas and dust. Also refers to any celestial object that has a cloudy appearance.
North Celestial Pole	The point in the Northern hemisphere around which all the stars appear to rotate. This is caused by the fact that the Earth is rotating on an axis that passes through the North and South celestial poles. The star Polaris lies less than a degree from this point and is therefore referred to as the "Pole Star".
Nova	Although Latin for "new" it denotes a star that suddenly becomes explosively bright at the end of its life cycle.
O - Open Cluster	One of the groupings of stars that are concentrated along the plane of the Milky Way. Most have an asymmetrical appearance and are loosely assembled. They contain from a dozen to many hundred stars.
P - Parallax	Parallax is the difference in the apparent position of an object against a background when viewed by an observer from two different locations. These positions and the actual position of the object form a triangle from which the apex angle (the parallax) and the distance of the object can be determined if the length of the baseline between the observing positions is known and the angular direction of the object from each position at the ends of the baseline has been measured. The traditional method in astronomy of determining the distance to a celestial object is to measure its parallax.
Parfocal	Refers to a group of eyepieces that all require the same distance from the focal plane of the telescope to be in focus. This means when you focus one parfocal eyepiece all the other parfocal eyepieces, in a particular line of eyepieces, will be in focus.
Parsec	The distance at which a star would show parallax of one second of arc. It is equal to 3.26 light-years, 206,265 astronomical units, or 30,8000,000,000,000 km. (Apart from the Sun, no star lies within one parsec of us.)
Point Source	An object which cannot be resolved into an image because it is too far away or too small is considered a point source. A planet is far away but it can be resolved as a disk. Most stars cannot be resolved as disks, they are too far away.
R - Reflector	A telescope in which the light is collected by means of a mirror.
Resolution	The minimum detectable angle an optical system can detect. Because of diffraction, there is a limit to the minimum angle, resolution. The larger the aperture, the better the resolution.
Right Ascension: (RA)	the angular distance of a celestial object measured in hours, minutes, and seconds along the Celestial Equator eastward from the Vernal Equinox.
S - Schmidt Telescope	Rated the most important advance in optics in 200 years, the Schmidt telescope combines the best features of the refractor and reflector for photographic purposes. It was invented in 1930 by Bernhard Voldemar Schmidt (1879-1935).
Sidereal Rate	This is the angular speed at which the Earth is rotating. Telescope tracking motors drive the telescope at this rate. The rate is 15 arc seconds per second or 15 degrees per hour.
T - Terminator	The boundary line between the light and dark portion of the moon or a planet.

U -	
Universe	The totality of astronomical things, events, relations and energies capable of being described objectively.
V -	
Variable Star	A star whose brightness varies over time due to either inherent properties of the star or something eclipsing or obscuring the brightness of the star.
W -	
Waning Moon	The period of the moon's cycle between full and new, when its illuminated portion is decreasing.
Waxing Moon	The period of the moon's cycle between new and full, when its illuminated portion is increasing.
Z -	
Zenith	The point on the Celestial Sphere directly above the observer.
Zodiac	The zodiac is the portion of the Celestial Sphere that lies within 8 deg on either side of the Ecliptic. The apparent paths of the Sun, the Moon, and the planets, with the exception of some portions of the path of Pluto, lie within this band. Twelve divisions, or signs, each 30 deg in width, comprise the zodiac. These signs coincided with the zodiacal constellations about 2,000 years ago. Because of the Precession of the Earth's axis, the Vernal Equinox has moved westward by about 30 deg since that time; the signs have moved with it and thus no longer coincide with the constellations.

## APPENDIX C LONGITUDES AND LATITUDES

	LONGITUDE		LATITUDE	
	degrees	min	degrees	min
<b>ALABAMA</b>				
Anniston	85	51	33	34.8
Auburn	85	26.4	32	40.2
Birmingham	86	45	33	34.2
Centreville	87	15	32	54
Dothan	85	27	31	19.2
Fort Rucker	85	43.2	31	16.8
Gadsden	86	5.4	33	58.2
Huntsville	86	46.2	34	39
Maxwell AFB	86	22.2	32	22.8
Mobile	88	15	30	40.8
Mobile Aeros	88	4.2	30	37.8
Montgomery	86	2.4	32	18
Muscle Shoals	87	37.2	34	45
Selma	86	59.4	32	20.4
Troy	86	1.2	31	52.2
Tuscaloosa	87	37.2	33	13.8
<b>ALASKA</b>				
Anchorage	149	51	61	13.2
Barrow	156	46.8	71	18
Fairbanks	147	52.2	64	49.2
Haines Hrbor	135	25.8	59	13.8
Homer	151	3	59	37.8
Juneau	134	34.8	58	22.2
Ketchikan	131	4.2	55	21
Kodiak	152	3	57	45
Nome	165	25.8	64	30
Sitka	135	21	57	4.2
Sitkinak	154	1.2	56	52.8
Skagway	135	31.8	59	45
Valdez	146	21	61	7.8
<b>ARIZONA</b>				
Davis-M AFB	110	52.8	32	10.2
Deer Valley	112	4.8	33	40.8
Douglas	109	3.6	31	27
Falcon Fld	111	43.8	33	28.2
Flagstaff	111	40.2	35	7.8
Fort Huachuc	110	21	31	36
Gila Bend	113	10.2	33	33
Goodyear	112	22.8	33	25.2
GrandCanyon	112	9	35	57
Kingman	113	57	35	16.2
Luke	112	22.8	33	31.8
Page	111	27	36	55.8
Payson	111	19.8	34	13.8
Phoenix	112	1.2	33	25.8
Prescott	112	25.8	34	39
Safford Awrs	109	40.8	32	49.2
Scottsdale	111	55.2	33	37.2
Show Low	110	0	34	16.2
Tucson	110	55.8	32	7.2
Williams AFB	111	40.2	33	18
Winslow	110	43.8	35	1.2
Yuma	115	0	33	6
Yuma Mcas	114	37.2	32	39
Yuma Prv Gd	114	2.4	32	51
<b>ARKANSAS</b>				
Blytheville	89	57	35	58.2
Camden	92	2.4	33	31.2
El Dorado	92	4.8	33	13.2
Fayetteville	94	10.2	36	0
Ft Smith	94	22.2	35	19.8
Harrison	93	9	36	16.2
Hot Springs	93	0.6	34	28.8
Jonesboro	90	39	35	49.8
Little Rock	92	22.8	35	13.2
Pine Bluff	91	55.8	34	10.2
Springdale	94	7.8	36	10.8
Texarkana	94	0	33	27
Walnut Ridge	90	55.8	36	7.8
<b>CALIFORNIA</b>				
Alameda	122	19.2	37	46.8
Alturas	120	31.8	41	28.8
Arcata	124	0.6	40	58.8
Bakersfield	119	3	35	25.8
Beale AFB	121	27	39	7.8
Beaumont	116	57	33	55.8
Bicycle Lk	116	37.2	35	16.8
Big Bear	116	40.8	34	16.2
Bishop	118	3.6	37	36
Blue Canyon	120	4.2	39	16.8

	LONGITUDE		LATITUDE	
	degrees	min	degrees	min
Blythe	114	43.2	33	37.2
Burbank	118	22.2	34	12
Campo	116	28.2	32	37.2
Carlsbad	117	16.8	33	7.8
Castle AFB	120	34.2	37	22.8
Chico	121	51	39	46.8
China Lake	117	40.8	35	40.8
Chino	117	37.8	33	58.2
Concord	122	3	37	58.8
Crescent Cty	124	13.8	41	46.8
Daggett	116	46.8	34	52.2
Edwards AFB	117	52.8	34	54
El Centro	115	40.8	32	49.2
El Monte	118	1.8	34	4.8
El Toro	117	43.8	33	40.2
Eureka	124	16.8	41	19.8
Fort Hunter	121	19.2	36	0
Fort Ord	121	46.2	36	40.8
Fresno	119	43.2	36	46.2
Fullerton	117	58.2	33	52.2
George AFB	117	22.8	34	34.8
Hawthorne	118	19.8	33	55.2
Hayward	122	7.2	37	39
Imperial	115	34.2	32	49.8
Imperial Bch	117	7.2	32	34.2
La Verne	117	46.8	34	6
Lake Tahoe	120	0	38	54
Lancaster	118	13.2	34	43.8
Livermore	121	49.2	37	42
Long Beach	118	9	33	49.2
Los Alamitos	118	3	33	46.8
Los Angeles	118	2.4	33	55.8
Mammoth	118	55.2	37	37.8
March AFB	117	16.2	33	52.8
Marysville	121	34.2	39	6
Mather AFB	121	1.8	38	34.2
Mcclellan	121	2.4	38	40.2
Merced	120	31.2	37	16.8
Miramar NAS	117	9	32	52.2
Modesto	120	57	37	37.8
Moffet	122	3	37	25.2
Mojave	118	9	35	3
Montague	122	31.8	41	43.8
Monterey	121	51	36	34.8
Mount Shasta	122	19.2	41	19.2
Mount Wilson	118	4.2	34	13.8
Napa	122	16.8	38	13.2
Needles	114	37.2	34	46.2
North Is	117	1.2	32	42
Norton AFB	117	13.8	34	6
Oakland	122	13.2	37	43.8
Ontario Intl	117	37.2	34	3
Oxnard	119	1.2	34	12
Palm Springs	116	3	33	49.8
Palmdale	118	7.8	35	3
Palo Alto	122	7.2	37	28.2
Paso Robles	120	37.8	35	40.2
Pillaro Pt	122	49.8	37	49.8
Point Mugu	119	7.2	34	7.2
Pt Arena	124	13.2	39	34.8
Pt Arguello	121	7.2	34	57
Pt Piedras	121	16.8	35	40.2
Red Bluff	122	15	40	9
Redding	122	1.8	40	30
Riverside	117	27	33	57
Sacramento	121	3	38	31.2
Salinas	121	3.6	36	40.2
San Carlos	122	15	37	31.2
San	117	37.2	33	25.2
Clemente				
San Diego	117	7.8	32	49.2
San	122	22.8	37	37.2
Francisco				
San Jose	121	55.2	37	22.2
San Luis Obi	120	39	35	13.8
San Mateo	117	34.8	33	22.8
San Miguel	120	2.4	34	1.8
Sandburg	118	43.8	34	45
Santa Ana	117	52.8	33	40.2
Santa Barb	119	49.8	34	25.8
Santa Maria	120	27	34	54
Santa Monica	118	27	34	1.2
Santa Rosa	122	49.2	38	31.2

	LONGITUDE		LATITUDE	
	degrees	min	degrees	min
Shelter Cove	124	4.2	40	1.8
Siskiyou	122	28.2	41	46.8
Stockton	121	15	37	54
Superior Val	117	0.6	35	19.8
Susanville	120	57	40	37.8
Thermal	116	10.2	33	37.8
Torrance	118	19.8	33	48
Travis AFB	121	55.8	38	16.2
Tahoe	120	7.8	39	19.2
Tustin Mcas	117	49.8	33	42
Ukiah	123	1.2	39	7.8
Van Nuys	118	28.8	34	13.2
Vandenberg	120	57	35	12
Visalia	119	2.4	36	19.2
<b>COLORADO</b>				
Air Force A	105	21	39	31.2
Akron	103	13.2	40	10.2
Alamosa	105	52.2	37	27
Aspen	106	52.2	39	13.2
Brmfield/Jef	105	7.2	39	54
Buckley	104	45	39	43.2
Colo Sprgs	104	43.2	38	49.2
Cortez	108	37.8	37	18
Craig-Moffat	107	31.8	40	30
Denver	104	52.2	39	45
Durango	107	45	37	9
Eagle	106	55.2	39	39
Englewood	104	49.8	39	34.2
Fort Carson	104	46.2	38	40.8
Fraser	105	3	39	34.2
Ft Col/Lovel	105	1.2	40	27
Ft Collins	105	4.8	40	34.8
Grand Jct	108	31.8	39	7.2
Greeley-Wld	104	37.8	40	25.8
Gunnison	106	55.8	38	33
La Junta	103	31.2	38	3
Lamar	102	3.6	38	7.2
Leadville	106	1.8	39	15
Limon	103	4.2	39	10.8
Montrose	107	52.8	38	30
Pueblo	104	31.2	38	16.8
Rifle	107	4.8	39	31.8
Salida	106	3	38	31.8
Trinidad	104	19.8	37	15
Winter Park	105	52.2	40	0
<b>CONNECTICUT</b>				
Bridgeport	73	7.8	41	10.2
Danbury	73	28.8	41	22.2
Groton	72	3	41	19.8
Hartford	72	39	41	43.8
New Haven	72	40.2	41	13.2
New London	72	4.8	41	18
Windsor Loc	72	40.8	41	55.8
<b>DELAWARE</b>				
Dover	75	28.2	39	7.8
Wilmington	75	3.6	39	40.2
<b>D.C. WASH</b>				
Washington	77	27.6	38	57
<b>FLORIDA</b>				
Apalachicola	85	1.8	29	43.8
Astor NAS	81	34.2	29	7.2
Avon Park G	81	33	28	4.8
Cape	80	33	28	28.2
Canaveral				
Cecil	81	52.8	30	13.2
Crestview	86	31.2	30	46.8
Cross City	83	0.6	29	37.2
Daytona Bch	81	3	29	10.8
Duke Fld	86	31.2	30	39
Eglin AFB	86	31.8	30	28.8
Egmont Key	82	46.2	27	36
Fort Myers	81	52.2	26	34.8
Ft Lauderdale	80	9	26	4.2
Ft Myers	81	52.2	26	39
Gainesville	82	16.2	29	40.8
Homestead	80	22.8	25	28.8
Hurlburt Fld	86	40.8	30	25.8
Jacksonville	81	40.8	30	13.8
Key West	81	45	24	

	LONGITUDE		LATITUDE	
	degrees	min	degrees	min
Melbourne	80	37.8	28	6
Miami	80	16.8	25	49.2
Naples	81	4.8	26	7.8
Nasa Shuttle	80	40.8	28	37.2
Orlando	81	19.2	28	25.8
Panama City	85	40.8	30	12
Patrick AFB	80	3.6	28	13.8
Pensacola	87	19.2	30	21
Ruskin	82	3.6	27	58.2
Saint Peters	82	40.8	27	55.2
Sanford	81	15	28	46.8
Sarasota	82	33	27	24
Tallahassee	84	22.2	30	22.8
Tampa Intl	82	31.8	27	58.2
Titusville	80	4.8	28	31.2
Tyndall AFB	85	34.8	30	4.2
Vero Beach	80	25.2	27	39
West Palm Beach	80	7.2	26	40.8
Whiting Fld	87	1.2	30	43.2
<b>GEORGIA</b>				
Albany	84	10.8	31	31.8
Alma	82	31.2	31	31.8
Athens	83	19.2	33	57
Atlanta	84	25.2	33	39
Augusta/Bush	81	58.2	33	22.2
Brunswick	81	22.8	31	9
Columbus	84	55.8	32	31.2
Dobbins AFB	84	31.2	33	55.2
Fort Benning	85	0	32	19.8
Ft Stewart	81	34.2	31	52.8
Hunter Aaf	81	9	32	1.2
La Grange	85	4.2	33	0.6
Macon/Lewis	83	39	32	42
Moody AFB	83	1.2	30	58.2
Robins AFB	83	3.6	32	37.8
Rome/Russell	85	10.2	34	21
Valdosta	83	16.8	30	46.8
Waycross	82	2.4	31	15
<b>HAWAII</b>				
Barbers Pt	158	7.2	21	31.8
Barking San Fr Frigate	160	1.8	22	3
Hilo	155	4.2	19	43.2
Honolulu Int	157	55.8	21	21
Kahului Maui	156	25.8	20	54
Kaneohe Mca	158	16.8	21	45
Kilauea Pt	159	40.2	22	22.8
Lanai-Lanai	156	57	20	48
Lihue-Kauai	159	21	21	58.8
Maui	156	49.8	20	58.2
Molokai	157	0.6	21	9
Upolo Pt Ln	156	28.2	20	25.2
Waimea-Koha	156	7.2	20	0
<b>IDAHO</b>				
Boise	116	13.2	43	34.2
Burley	113	46.2	42	31.8
Challis	114	13.2	44	31.2
Coeur d'Alene	116	49.2	47	46.2
Elk City	115	25.8	45	49.2
Gooding	115	10.2	43	0
Grangeville	116	7.8	45	55.2
Idaho Falls	112	4.2	43	31.2
Lewiston	117	1.2	46	22.8
Malad City	112	19.2	42	10.2
Malta	113	22.2	42	18
Mccall	116	0.6	44	52.8
Mullan	115	4.8	47	28.2
Pocatello	112	3.6	42	55.2
Salmon	113	5.4	45	10.8
Soda Springs	111	34.8	42	39
Sun Valley	114	1.8	43	30
Twin Falls	114	28.8	42	28.8
<b>ILLINOIS</b>				
Alton	90	3	38	52.8
Aurora	88	19.2	41	46.2
Bistate Park	90	9	38	34.2
Bloomington	88	55.8	40	28.8
Bradford	89	3.6	41	9.6
Cairo	89	13.2	37	4.2
Carbondale	89	15	37	46.8
Centralia	89	5.4	38	30.6
Champaign	88	16.8	40	1.8
Chicago	87	39	41	54
Danville	87	3.6	40	12
DeKalb	88	43.2	41	55.8
Decatur	88	52.2	39	49.8
Du Page	88	15	41	55.2
Galesburg	90	25.8	40	55.8

	LONGITUDE		LATITUDE	
	degrees	min	degrees	min
Glenview	87	49.2	42	4.8
NAS				
Kankakee	87	51	41	4.2
Macomb	90	39.6	40	31.2
Marion	89	0	37	45
Marseilles	88	40.8	41	22.2
Mattoon	88	16.8	39	28.8
Moline/Quad	90	31.2	41	27
Mount Vernon	88	51.6	38	19.2
Peoria	89	40.8	40	40.2
Quincy	91	1.2	39	55.8
Rockford	89	0.6	42	12
Salem	88	57.6	38	37.8
Scott AFB	89	51	38	33
Springfield	89	40.2	39	51
Sterling	89	40.2	41	44.4
Taylorville	89	19.8	39	31.8
Vandalia	89	10.2	38	59.4
<b>INDIANA</b>				
Bakalar	86	3	39	22.8
Bloomington	86	37.2	39	7.8
Elkhart	86	0	41	43.2
Evansville	87	31.8	38	3
Fort Wayne	85	1.2	41	0
Gary	87	25.2	41	37.2
Grissom AFB	86	9	40	39
Indianapolis	86	16.2	39	43.8
Muncie	85	22.8	40	13.8
South Bend	86	19.2	41	42
Terre Haute	87	1.8	39	27
W Lafayette	86	55.8	40	25.2
<b>IOWA</b>				
Burlington	91	7.2	40	46.8
Cedar Rapids	91	4.2	41	52.8
Des Moines	93	39	41	31.8
Dubuque	90	4.2	42	24
Estherville	94	45	43	24
Fort Dodge	94	10.8	42	33
Lamoni	93	55.8	40	37.2
Mason City	93	19.8	43	9
Ottumwa	92	27	41	6
Sioux City	96	22.8	42	24
Spencer	95	9	43	10.2
Waterloo Mun	92	2.4	42	33
<b>KANSAS</b>				
Chanute	95	28.8	37	40.2
Col. J Jabar	97	13.2	37	45
Concordia	97	39	39	33
Dodge City	99	58.2	37	46.2
Elkhart	101	52.8	37	0
Emporia	96	1.2	38	19.8
Ft Leavenwrth	94	55.2	39	22.2
Ft Riley	96	46.2	39	3
Garden City	100	43.2	37	55.8
Goodland	101	4.2	39	22.2
Hays	99	16.2	38	51
Hill City	99	49.8	39	22.8
Hutchinson	97	52.2	38	4.2
Johnson Cnty	94	52.8	38	49.2
Liberal	100	58.2	37	3
Manhattan	96	40.2	39	9
Mcconnell Af	97	16.2	37	37.2
Medicine Ldg	98	34.8	37	18
Olathe	94	5.4	38	51
Russell	98	49.2	38	52.2
Salina	97	39	38	48
Topeka	95	37.2	39	4.2
Topeka/Forbe	95	40.2	38	57
Wichita	97	25.8	37	39
<b>KENTUCKY</b>				
Bowling Gren	86	25.8	36	58.2
Ft Campbell	87	3	36	40.2
Ft Knox	85	58.2	37	54
Jackson	83	19.2	37	36
Lexington	85	0	38	3
London	84	4.2	37	4.8
Louisville	85	40.2	38	13.8
Owensboro	87	10.2	37	45
Paducah	88	46.2	37	4.2
Pikeville	82	31.2	37	28.8
<b>LOUISIANA</b>				
Alexandria	92	1.8	31	22.8
Barksdale	93	40.2	32	30
Baton Rouge	91	9	30	31.8
Boothville	89	40.2	29	33
Cameron Heli	93	1.8	29	46.8
Claiborne R	92	57	31	13.2
England AFB	92	33	31	19.8
Eugene Is.	91	46.8	28	28.2
Fort Polk	93	1.2	31	3

	LONGITUDE		LATITUDE	
	degrees	min	degrees	min
Grand Isle	90	4.2	29	10.8
High Island	94	2.4	28	7.8
Houma	90	39	29	34.2
Intercoastal	92	7.2	29	43.8
Lafayette	92	0	30	12
Lake Charles	93	13.2	30	7.2
Lk Palourde	91	0.6	29	42
Missippi Can	89	3	28	46.8
Monroe	92	3	32	31.2
Morgan City	91	1.2	29	42
New Iberia	91	52.8	30	1.8
New Orleans	90	15	29	58.8
S Marsh Isl	91	58.8	28	18
Shreveport	93	45	32	31.2
Slidel	89	49.2	30	21
<b>MAINE</b>				
Augusta	69	4.8	44	19.2
Bangor	68	49.2	44	48
Bar Harbor	68	22.2	44	27
Brunswick	69	55.8	43	52.8
Caribou Mun	68	1.2	46	52.2
Greenville	69	33	45	27
Houlton	67	46.8	46	7.8
Loring AFB	67	52.8	46	57
Portland	70	19.2	43	39
Presque Isle	68	3	46	40.8
Rockland	69	7.2	44	4.2
Rumford	70	52.8	44	52.8
<b>MARYLAND</b>				
Andrews AFB	76	52.2	38	49.2
Baltimore	76	40.2	39	10.8
Fort Meade	76	46.2	39	4.8
Hagerstown	77	43.2	39	42
Ocean City	75	7.8	38	33
Patuxent	76	2.4	38	16.8
Phillips	76	10.2	39	28.2
Salisbury	75	3	38	19.8
<b>MASSACHUSETTS</b>				
Bedford	71	16.8	42	28.2
Beverly	70	55.2	42	34.8
Boston	71	1.8	42	22.2
Cape Cod	70	3	41	46.8
Chatham	69	58.2	41	40.2
Fort Devens	71	3.6	42	34.2
Hyannis	70	16.8	41	40.2
Lawrence	71	7.2	42	43.2
Marthas Vine	70	37.2	41	24
Nantucket	70	4.2	41	15
New Bedford	70	58.2	41	40.8
Norwood	71	10.8	42	10.8
Otis ANGB	70	31.2	41	39
Pittsfield	73	10.8	42	15.6
S Weymouth	70	55.8	42	9
Westfield	72	43.2	42	10.2
Westover	72	31.8	42	12
Worcester	71	52.2	42	16.2
<b>MICHIGAN</b>				
Alpena	83	34.2	45	4.2
Ann Arbor	83	45	42	13.2
Battle Creek	85	13.8	42	18
Benton Harbor	86	25.8	42	7.8
Chippewa	84	28.2	46	15
Coopersville	85	57	43	4.2
Copper Harb	87	51	47	28.2
Detroit	83	1.2	42	25.2
Escanaba	87	4.8	45	43.8
Flint/Bishop	83	45	42	58.2
Grand Rapids	85	31.2	42	52.8
Hancock	88	3	47	10.2
Harbor Beach	82	31.8	43	49.8
Houghton Lake	84	40.8	44	22.2
Iron Mtn	88	7.2	45	49.2
Ironwood	90	7.8	46	31.8
Jackson	84	28.2	42	16.2
Kalamazoo	85	33	42	13.8
Lansing	84	3.6	42	46.2
Manistee	86	15	44	16.2
Marquette	87	57	46	52.8
Menominee	87	37.8	45	7.2
Muskegon	86	15	43	10.2
Pellston	84	4.8	45	34.2
Pontiac	83	25.2	42	40.2
Saginaw	84	4.8	43	31.8
Sault Ste M	84	22.2	46	28.2
Sawyer AFB	87	2.4	46	21
Selfridge	82	49.8	42	37.2
Seul Choix	85	55.2	45	55.2
Traverse Cty	85	34.8	44	43.8

	LONGITUDE		LATITUDE	
	degrees	min	degrees	min
Wurtsmith	83	2.4	44	27
Ypsilanti	83	31.8	42	13.8
<b>MINNESOTA</b>				
Albert Lea	93	22.2	43	40.8
Alexandria	95	22.8	45	52.2
Bemidji Muni	94	55.8	47	30
Brainerd-Crw	94	7.8	46	24
Detroit Laks	95	52.8	46	49.2
Duluth	92	10.8	46	49.8
Ely	91	49.2	47	54
Fairmont	94	25.2	43	39
Fergus Falls	96	4.2	46	18
Grand Rapids	93	31.2	47	13.2
Hibbing	92	51	47	22.8
Intl Falls	93	22.8	48	34.2
Litchfield	94	31.2	45	7.8
Mankato	93	55.2	44	13.2
Marshall Arpt	95	49.2	44	27
Minneapolis	93	28.2	44	49.8
Park Rapids	95	4.2	46	54
Pequot Lake	94	19.2	46	36
Rochester	92	3	43	55.2
Saint Paul	93	3	44	55.8
St Cloud	94	4.2	45	33
Thief River	96	10.8	48	4.2
Tofte	90	49.8	47	34.8
Warroad	95	21	48	55.8
Worthington	95	34.8	43	39
<b>MISSISSIPPI</b>				
Columbus	88	27	33	39
AFB				
Golden Trian	88	34.8	33	27
Greenville	90	58.8	33	28.8
Greenwood	90	4.8	33	30
Gulfport	89	4.2	30	24
Hattiesburg	89	19.8	31	28.2
Jackson	90	4.8	32	19.2
Keesler AFB	88	55.2	30	25.2
Laurel	89	10.2	31	40.2
Mccomb	90	28.2	31	10.8
Meridian NAS	88	34.2	32	33
Meridian/Key	88	45	32	19.8
Natchez	91	15	31	37.2
Oxford	89	32.4	34	23.4
Tupelo	88	46.2	34	16.2
<b>MISSOURI</b>				
Columbia	92	13.2	38	49.2
Cape	89	34.8	37	13.8
Girardeau				
Ft Leonard	92	7.8	37	45
Jefferson City	92	10.2	38	36
Joplin	94	3	37	10.2
Kansas City	94	43.2	39	19.2
Kirksville	92	33	40	6
Monett	94	21	37	19.8
Muskogee	95	21.6	35	39.6
Poplar Bluff	90	28.2	36	46.2
Richards-Geb	94	33	38	51
Spickard	93	43.2	40	15
Springfield	93	22.8	37	13.8
St Joseph	95	31.8	40	16.8
St Louis	90	22.2	38	45
Vichy/Rolla	91	46.2	38	7.8
West Plains	92	25.2	37	13.2
Whiteman	93	33	38	43.8
AFB				
<b>MONTANA</b>				
Billings	108	31.8	45	48
Bozeman	111	9	45	46.8
Broadus	105	40.2	45	40.2
Butte	112	3	45	57
Cut Bank	112	22.2	48	36
Dillon	112	33	45	15
Drummond	113	9	46	40.2
Glasgow	106	37.2	48	13.2
Glendive	104	4.8	47	7.8
Great Falls	111	22.2	47	28.8
Harlowton	109	49.8	46	25.8
Havre	109	46.2	48	33
Helena	112	0	46	36
Jordan	106	55.8	47	19.8
Kalispell	114	16.2	48	18
Lewiston	109	27	47	3
Livingston	110	25.8	45	42
Malmstrom	111	10.8	47	30
Miles City	105	52.2	46	25.8
Missoula	114	4.8	46	55.2
Monida	112	19.2	44	34.2
Sidney	104	10.8	47	43.2
W Yellowstone	111	0.6	44	39

	LONGITUDE		LATITUDE	
	degrees	min	degrees	min
<b>NEBRASKA</b>				
Ainsworth	99	58.8	42	34.8
Alliance	102	4.8	42	3
Beatrice	96	45	40	19.2
Broken Bow	99	39	41	25.8
Burwell	99	9	41	46.8
Chadron	103	4.8	42	49.8
Columbus	97	21	41	27
Cozad	100	0	40	52.2
Falls City	95	34.8	40	4.2
Grand Island	98	19.2	40	58.2
Hastings	98	25.8	40	36
Imperial	101	23.4	40	19.8
Kearney	99	0	40	43.8
Lincoln Muni	96	45	40	51
Mccook	100	34.8	40	13.2
Mullen	101	3	42	3
Norfolk	97	25.8	41	58.8
North Omaha	96	1.2	41	22.2
North Platte	100	40.8	41	7.8
O'neill	98	40.8	42	28.2
Offutt AFB	95	55.2	41	7.2
Omaha	95	5.4	41	18
Ord/Sharp	98	57	41	37.2
Scottsbluff	103	3.6	41	52.2
Sidney Muni	102	58.8	41	6
Valentine	100	33	42	52.2
<b>NEVADA</b>				
Austin	117	7.8	39	49.8
Battle Mtn	116	52.2	40	37.2
Caliente	114	31.2	37	37.2
Elko	115	46.8	40	49.8
Ely/Yelland	114	51	39	16.8
Eureka	115	58.2	39	30
Fallon NAS	118	4.2	39	25.2
Hawthorne	118	37.8	38	33
Ind Sprng Rn	115	34.2	36	31.8
Las Vegas	115	10.2	36	4.8
Lovelock	118	55.2	40	6
Mercury	116	1.2	36	37.2
Nellis AFB	115	1.8	36	13.8
Owyhee	116	10.2	42	34.8
Reno	119	46.8	39	30
Tonopah	117	4.8	38	4.2
Wildhorse	116	15	41	19.8
Winnemucca	117	4.8	40	54
Yucca Flat	116	4.8	37	34.8
<b>NEW HAMPSHIRE</b>				
Berlin	71	10.8	44	34.8
Concord	71	3	43	12
Jaffrey	72	0	42	48
Keene	72	16.2	42	54
Laconia	71	25.8	43	34.2
Lebanon	72	1.8	43	37.8
Manchester	71	25.8	42	55.8
Mt Washngtn	71	1.8	44	16.2
Nashua	71	31.2	42	46.8
Pease AFB	70	49.2	43	4.8
Wolfeboro	71	22.8	44	0
<b>NEW JERSEY</b>				
Atlantic Ctlly	74	34.2	39	27
Barnegat Ls	74	16.8	40	16.8
Fairfield	74	16.8	40	52.2
Lakehurst	74	21	40	1.8
Mcguire AFB	74	3.6	40	1.2
Millville	75	4.2	39	22.2
Morristown	74	25.2	40	48
Newark Intl	74	10.2	40	42
Teterboro	74	3	40	51
Trenton	74	49.2	40	16.8
<b>NEW MEXICO</b>				
Albuquerque	106	3.6	35	3
Cannon	103	19.2	34	22.8
Carlsbad	104	16.2	32	19.8
Clayton Arpt	103	9	36	27
Corona	105	40.8	34	6
Deming	107	4.2	32	15
Farmington	108	13.8	36	45
Gallup/Clark	108	46.8	35	31.2
Grants	107	5.4	35	10.2
Hobbs	103	1.2	32	40.8
Holloman	106	0.6	32	51
AFB				
Las Cruces	106	46.2	32	18
Las Vegas	105	9	35	39
Los Alamos	106	16.8	35	52.8
Moriarity	106	3	34	58.8
Northrup Str	106	2.4	32	54
Raton	104	3	36	44.4
Roswell	104	31.8	33	18

	LONGITUDE		LATITUDE	
	degrees	min	degrees	min
Santa Fe	106	4.8	35	37.2
Silver City	108	10.2	32	37.8
Socorro	106	5.4	34	4.2
Taos	105	34.2	36	25.2
Truth Or Con	107	16.2	33	13.8
Tucumcari	103	3.6	35	10.8
White Sands	106	2.4	32	37.8
<b>NEW YORK</b>				
Albany	73	4.8	42	45
Ambrose	74	22.2	40	45
Binghamton	75	58.8	42	13.2
Buffalo	78	43.8	42	55.8
Dansville	78	1.2	42	58.2
Elmira	76	5.4	42	10.2
Farmingdale	73	25.8	40	43.8
Fort Drum	75	43.8	44	3
Glens Falls	73	37.2	43	21
Griffiss AFB	75	2.4	43	13.8
Islip	73	0.6	40	46.8
Ithaca	76	28.2	42	28.8
Jamestown	79	15	42	9
Massena	74	51	44	55.8
Monticello	74	4.8	41	42
New York	73	58.8	40	46.2
Newburgh	74	0.6	41	30
Niagara Fall	78	57	43	6
Ogdensburg	75	2.4	44	40.8
Oneonta	75	7.2	42	52.2
Plattsburgh	73	28.2	44	39
Rochester	77	40.2	43	7.2
Saranac Lk	74	1.2	44	22.8
Schenectady	73	55.8	42	51
Syracuse	76	7.2	43	7.2
Utica	75	22.8	43	9
Watertown	76	1.2	44	0
Westhampton	72	37.8	40	51
White Plains	73	43.2	41	4.2
<b>NORTH CAROLINA</b>				
Asheville	82	33	35	25.8
Cape Hattera	75	33	35	16.2
Charlotte	80	55.8	35	13.2
Cherry Point	76	52.8	34	54
Dare Co Gr	76	3	36	7.8
Diamond Sho	75	3	35	15
Elizabeth	76	10.8	36	16.2
Fayetteville	78	52.8	35	0
Fort Bragg	78	55.8	35	7.8
Greensboro	79	57	36	4.8
Hickory	81	22.8	35	45
Hot Springs	82	49.2	35	54
Jacksonville	77	37.2	34	49.2
Kinston	77	37.8	35	19.2
Mackall Aaf	79	3	35	1.8
Manteo Arpt	75	40.8	35	55.2
New Bern	77	3	35	4.8
New River	77	25.8	34	42
Pope AFB	79	1.2	35	10.2
Raleigh-Durh	78	46.8	35	52.2
Rocky Mt	77	52.8	35	51
Southern Pin	79	23.4	35	14.4
Wilmington	77	55.2	34	16.2
Winston-Salem	80	13.8	36	7.8
<b>NORTH DAKOTA</b>				
Bismarck	100	45	46	46.2
Devil's Lake	98	5.4	48	7.2
Dickenson	102	4.8	46	46.8
Fargo	96	4.8	46	54



	LONGITUDE		LATITUDE	
	degrees	min	degrees	min
<b>OKLAHOMA</b>				
Altus AFB	99	16.2	34	40.2
Ardmore	97	1.2	34	18
Bartlesville	96	0	36	45
Clinton	99	1.2	35	21
Enid	97	4.8	36	22.8
Fort Sill	98	2.4	34	39
Gage	99	46.2	36	18
Hobart	99	3	35	0
Lawton	98	25.2	34	34.2
Mcalester	95	46.8	34	52.8
Norman	97	28.2	35	13.8
Oklahoma	97	3.6	35	24
Page	94	37.2	34	40.8
Ponca City	97	0.6	36	43.8
Stillwater	97	5.4	36	9.6
Tinker AFB	97	22.8	35	25.2
Tulsa	95	5.4	36	12
Vance AFB	97	55.2	36	19.8
<b>OREGON</b>				
Astoria	123	52.8	46	9
Aurora	122	45	45	15
Baker	117	49.2	44	49.8
Brookings	124	28.2	42	4.8
Burns Arpt	118	57	43	36
Cape Blanco	124	57	43	22.8
Cascade	121	52.8	45	40.8
Corvallis	123	16.8	44	30
Eugene	123	13.2	44	7.2
Hillsboro	122	57	45	31.8
Klamath Fall	121	43.8	42	9
La Grande	118	0	45	16.8
Lake View	120	21	42	10.8
Meacham	118	2.4	45	30
Medford	122	52.2	42	22.2
Newport	124	3	44	37.8
North Bend	124	15	43	25.2
Ontario	117	1.2	44	1.2
Pendleton	118	51	45	40.8
Portland	122	3.6	45	36
Redmond	121	9	44	16.2
Roseburg	123	22.2	43	13.8
Salem	123	0	44	55.2
Sexton	123	22.2	42	37.2
The Dalles	121	9	45	37.2
Troutdale	122	2.4	45	33
<b>PENNSYLVANIA</b>				
Allentown	75	25.8	40	39
Altoona	78	19.2	40	18
Beaver Falls	80	19.8	40	45
Blairsville	79	5.4	40	16.2
Bradford	78	37.8	41	48
Dubois	78	5.4	41	10.8
Erie	80	10.8	42	4.8
Franklin	79	52.2	41	22.8
Harrisburg	76	51	40	13.2
Johnstown	78	49.8	40	19.2
Lancaster	76	1.8	40	7.8
Latrobe	79	2.4	40	16.8
Middletown	76	46.2	40	12
Muir	76	34.2	40	25.8
Nth Philadel	75	1.2	40	4.8
Philadelphia	75	15	39	52.8
Philipsburg	78	7.8	41	28.2
Pittsburgh	79	55.8	40	21
Reading	75	58.2	40	22.8
Site R	77	25.8	39	43.8
State Colleg	77	49.8	40	51
Wilkes-Barre	75	43.8	41	19.8
Williamsport	76	55.2	41	15
Willow Grove	75	9	40	12
<b>RHODE ISLAND</b>				
Block Island	71	34.8	41	10.2
Nth Kingston	71	25.2	41	36
Providence	71	25.8	41	43.8
<b>SOUTH CAROLINA</b>				
Anderson	82	43.2	34	30
Beaufort	80	43.2	32	28.8
Charleston	80	1.8	32	54
Columbia	81	7.2	33	57
Florence	79	43.2	34	10.8
Greenville	82	21	34	51
Mcentire	80	4.8	33	55.2

	LONGITUDE		LATITUDE	
	degrees	min	degrees	min
Myrtle Beach	78	55.8	33	40.8
Shaw AFB	80	28.2	33	58.2
Spartanburg	81	57.6	34	55.2
<b>SOUTH DAKOTA</b>				
Aberdeen	98	25.8	45	27
Brookings	96	4.8	44	18
Chamberlain	99	19.2	43	48
Custer	103	3.6	43	46.2
Ellsworth	103	0.6	44	9
Huron	98	13.2	44	22.8
Lemmon	102	10.2	45	55.8
Mitchell	98	1.8	43	46.2
Mobridge	100	25.8	45	31.8
Philip	101	3.6	44	3
Pierre	100	16.8	44	22.8
Rapid City	103	4.2	44	3
Redig	103	19.2	45	9.6
Sioux Falls	96	43.8	43	34.8
Watertown	97	9	44	55.2
Yankton	97	22.8	42	55.2
<b>TENNESSEE</b>				
Bristol	82	2.4	36	28.8
Chattanooga	85	1.2	35	1.8
Clarksville	87	25.2	36	37.2
Crossville	85	4.8	35	57
Dyersburg	89	2.4	36	1.2
Jackson	88	55.2	35	36
Knoxville	83	58.8	35	49.2
Memphis Intl	90	0	35	3
Monteagle	85	30.6	35	9
Nashville	86	40.8	36	7.2
Smyrna	86	3	36	0
<b>TEXAS</b>				
Abilene	99	40.8	32	25.2
Alice	98	1.8	27	43.8
Amarillo	101	4.2	35	13.8
Austin	97	4.2	30	18
Bergstrom Af	97	40.8	30	12
Big Sky	101	28.8	32	23.4
Big Spring	101	27	32	18
Brownsville	97	25.8	25	54
Brownwood	98	57.6	31	47.4
Carswell AFB	97	25.8	32	46.8
Chase NAS	97	40.2	28	22.2
Childress	100	16.8	34	25.8
College Stn	96	22.2	30	34.8
Corpus Chrst	97	3	27	46.2
Cotulla	99	13.2	28	27
Dalhart	102	33	36	1.2
Dallas/FW	97	1.8	32	54
Del Rio	100	55.2	29	22.2
Dyess AFB	99	51	32	25.8
El Paso	106	2.4	31	48
Ellington Af	95	10.2	29	37.2
Fort Worth	97	21	32	49.2
Ft Hood Aaf	97	43.2	31	9
Galveston	94	52.2	29	16.2
Gray AFB	97	49.8	31	4.2
Greenville	96	4.2	33	4.2
Guadalupe	104	4.8	31	49.8
Harlingen	97	40.2	26	13.8
Hondo	99	10.2	29	21
Houston	95	21	29	58.2
Junction	99	46.2	30	30
Kelly AFB	98	34.8	29	22.8
Kerrville	99	4.8	29	58.8
Killeen	97	40.8	31	4.8
Kingsville	97	49.2	27	30
Laredo Intl	99	28.2	27	31.8
Laughlin AFB	100	46.8	29	22.2
Longview	94	43.2	32	22.8
Lubbock	101	49.2	33	39
Lufkin	94	45	31	13.8
Marfa	104	1.2	30	22.2
Mcallen	98	13.8	26	10.8
Midland	102	10.8	31	57
Mineral Wlls	98	4.2	32	46.8
Palacios	96	15	28	43.2
Paris/Cox	95	27	33	37.8
Plainview	101	42.6	34	10.2
Port Arthur	94	1.2	30	34.8
Reese AFB	102	3	33	36
Rockport	97	1.8	28	4.8

	LONGITUDE		LATITUDE	
	degrees	min	degrees	min
San Angelo	100	3	31	22.2
San Antonio	98	28.2	29	31.8
Sanderson	102	25.2	30	10.2
South Brazos	95	52.2	28	1.8
Stephenville	98	10.8	32	13.2
Temple	97	25.2	31	9
Tyler/Pounds	95	2.4	32	22.2
Victoria	96	55.2	28	51
Wichita Flls	98	3	33	58.8
Wink	103	1.2	31	46.8
<b>UTAH</b>				
Blanding	109	46.8	38	1.8
Bullfrog Mar	110	4.2	37	30
Cedar City	113	0.6	37	42
Delta	112	34.8	39	19.8
Eagle Range	113	4.2	41	3
Green River	110	9	39	0
Hanksville	110	43.2	38	22.2
Hill AFB	111	58.2	41	7.2
Logan	111	51	41	46.8
Milford	113	1.8	38	43.2
Moab	109	45	38	46.2
Ogden	112	1.2	41	10.8
Price/Carbon	110	45	39	37.2
Provo	111	43.2	40	13.2
Roosevelt	110	37.8	40	30
Saint George	113	3.6	37	4.8
Salt Lake Ct	111	58.2	40	46.8
Tooele	112	1.2	40	10.2
Vernal	109	31.2	40	27
Wendover	114	3	41	13.2
<b>VERMONT</b>				
Burlington	73	9	44	28.2
Montpelier	72	34.2	44	12
Newport	72	19.8	45	33
Rutland	73	57	43	31.8
St Johnsbury	72	1.2	44	25.2
Wilmington	72	52.8	42	52.8
<b>VIRGINIA</b>				
Charlottes	78	27	38	7.8
Chesapeake	76	1.2	37	30
Danville	79	19.8	36	34.2
Fort Belvoir	77	10.8	38	43.2
Fort Eustis	76	37.2	37	7.8
Hot Springs	79	49.2	37	57
Langley AFB	76	22.2	37	4.8
Lynchburg	79	1.2	37	19.8
Newport	76	3	37	7.8
News				
Norfolk NAS	76	16.8	36	55.8
Norfolk Rgnl	76	1.2	36	54
Oceana NAS	76	1.8	36	49.2
Quantico Mca	77	1.8	38	30
Richmond	77	19.8	37	30
Roanoke	79	58.2	37	19.2
Muni				
Staunton	78	51	38	16.2
Volens	78	58.8	36	57
Wallops Sta	75	28.8	37	51
<b>WASHINGTON</b>				
Bellingham	122	31.8	48	48
Bremerton	122	46.2	47	28.8
Burlington	122	19.8	48	30
Colville	118	28.2	48	52.8
Ephrata	119	31.2	47	19.2
Everet/Paine	122	16.8	47	55.2
Fairchild	117	39	47	37.2
Fort Lewis	122	34.8	47	4.8
Hanford	119	3.6	46	34.2
Hoquiam	123	58.2	46	58.2
Mchord AFB	122	28.8	47	9
Moses Lake	119	19.2	47	12
Oak Harbor	122	40.8	48	15
Olympia	122	5.4	46	58.2
Omak	119	31.8	48	25.2
Pasco	119	7.2	46	16.2
Port Angeles	123	3	48	7.2
Pullman	117	7.2	46	45
Quillayute	124	33	47	57
Renton	122	13.2	47	30
Seattle	122	1.8	47	27

	LONGITUDE		LATITUDE	
	degrees	min	degrees	min
Walla Walla	118	16.8	46	6
Wenatchee	120	1.2	47	24
Whidbey Is	122	39	48	21
Yakima	120	31.8	46	34.2
<b>WEST VIRGINIA</b>				
Beckley	81	7.2	37	46.8
Bluefield	81	13.2	37	18
Charleston	81	3.6	38	22.2
Clarksburg	80	13.8	39	16.8
Elkins	79	51	38	52.8
Huntington	82	33	38	22.2
Lewisburg	80	2.4	37	52.2
Martinsburg	77	58.8	39	24
Morgantown	79	55.2	39	39
Parkersburg	81	25.8	39	21
Wheeling	80	39	40	10.8
Wh Sulphur	80	1.2	37	27.6

	LONGITUDE		LATITUDE	
	degrees	min	degrees	min
<b>WISCONSIN</b>				
Appleton	88	31.2	44	15
Eau Claire	91	28.8	44	52.2
Green Bay	88	7.8	44	28.8
Janesville	89	1.8	42	37.2
La Crosse	91	15	43	52.2
Lone Rock	90	10.8	43	12
Madison	89	19.8	43	7.8
Manitowac	87	40.2	44	7.8
Milwaukee	87	5.4	42	57
Mosinee	89	40.2	44	46.8
Neenah	88	31.8	44	13.2
Oshkosh	88	34.2	44	0
Rhineland	89	27	45	37.8
Rice Lake	91	43.2	45	28.8
Volk Fld	90	16.2	43	55.8
Wausau	89	37.2	44	55.2

	LONGITUDE		LATITUDE	
	degrees	min	degrees	min
<b>WYOMING</b>				
Big Piney	110	0.6	42	34.2
Casper	106	28.2	42	55.2
Cheyenne	104	49.2	41	9
Cody	109	1.2	44	31.2
Douglas	105	22.8	42	45
Evanston	111	0	41	19.8
Gillette	105	31.8	44	21
Jackson	110	43.8	43	36
Lander	108	43.8	42	49.2
Laramie	105	40.8	41	19.2
Moorcroft	104	48.6	44	21
Rawlins	107	1.2	41	48
Riverton	108	27	43	3
Rock Springs	109	4.2	41	36
Sheridan	106	58.2	44	46.2
Worland	107	58.2	43	58.2
Yellowstone	110	25.2	44	33

## CANADA

CITY	PROVINCE	LONGITUDE	LATITUDE
Calgary	Alberta	114 7	51 14
Churhill	Newfoundland	94 0	58 45
Coppermine	Northwest Terr.	115 21	67 49
Edmonton	Alberta	113 25	53 34
Frederickton	New Brunswick	66 40	45 57
Ft Mcpherson	Northwest Terr	134 50	67 29
Goose Bay	Newfoundland	60 20	53 15
Halifax	Nova Scotia	63 34	44 39
Hazleton	BC	127 38	55 15
Kenora	Ontario	94 29	49 47
Labrador City	Labrador	66 52	52 56
Montreal	Quebec	73 39	45 32
Mt. Logan	Yukon	140 24	60 34
Nakina	Yukon	132 48	59 12
Ottawa	Ontario	75 45	45 18
Peace River	Alberta	117 18	56 15
Pr. Edward Isl	Nova Scotia	63 9	46 14
Quebec	Quebec	71 15	46 50
Regina	Saskatchewan	104 38	50 30
Saskatoon	Saskatchewan	101 32	52 10
St. Johns	Newfoundland	52 43	47 34
Toronto	Ontario	79 23	43 39
Vancouver	BC	123 7	49 16
Victoria	BC	123 20	48 26
Whitehorse	Yukon	135 3	60 43
Winnipeg	Manitoba	97 9	49 53

CITY	COUNTRY	LONGITUDE	LATITUDE
Glasgow	Scotland	4 15 w	55 50 n
Guatemala City	Guatemala	90 31 w	14 37 n
Guayaquil	Ecuador	79 56 w	2 10 s
Hamburg	Germany	10 2 e	53 33 n
Hammerfest	Norway	23 38 e	70 38 n
Havana	Cuba	82 23 w	23 8 n
Helsinki	Finland	25 0 e	60 10 n
Hobart	Tasmania	147 19 e	42 52 s
Iquique	Chile	70 7 w	20 10 s
Irkutsk	Russia	104 20 e	52 30 n
Jakarta	Indonesia	106 48 e	6 16 s
Johannesburg	South Africa	28 4 e	26 12 s
Kingston	Jamaica	76 49 w	17 59 n
La Paz	Bolivia	68 22 w	16 27 s
Leeds	England	1 30 w	53 45 n
Lima	Peru	77 2 w	12 0 s
Liverpool	England	3 0 w	53 25 n
London	England	0 5 w	51 32 n
Lyons	France	4 50 e	45 45 n
Madrid	Spain	3 42 w	40 26 n
Manchester	England	2 15 w	53 30 n
Manila	Philippines	120 57 e	14 35 n
Marseilles	France	5 20 e	43 20 n
Mazatlán	Mexico	106 25 w	23 12 n
Mecca	Saudi Arabia	39 45 e	21 29 n
Melbourne	Australia	144 58 e	37 47 s
Mexico City	Mexico	99 7 w	19 26 n
Milan	Italy	9 10 e	45 27 n
Montevideo	Uruguay	56 10 w	34 53 s
Moscow	Russia	37 36 e	55 45 n
Munich	Germany	11 35 e	48 8 n
Nagasaki	Japan	129 57 e	32 48 n
Nagoya	Japan	136 56 e	35 7 n
Nairobi	Kenya	36 55 e	1 25 s
Nanjing	China	118 53 e	32 3 n
Naples	Italy	14 15 e	40 50 n
Newcastle	England	1 37 w	54 58 n
Odessa	Ukraine	30 48 e	46 27 n
Osaka	Japan	135 30 e	34 32 n
Oslo	Norway	10 42 e	59 57 n
Panama City	Panama	79 32 w	8 58 n
Paramaribo	Surinam	55 15 w	5 45 n
Paris	France	2 20 e	48 48 n
Beijing	China	116 25 e	39 55 n
Perth	Australia	115 52 e	31 57 s
Plymouth	England	4 5 w	50 25 n
Rio de Janeiro	Brazil	43 12 w	22 57 s
Rome	Italy	12 27 e	41 54 n
Salvador	Brazil	38 27 w	12 56 s
Santiago	Chile	70 45 w	33 28 s
St. Petersburg	Russia	30 18 e	59 56 n
Sao Paulo	Brazil	46 31 w	23 31 s
Shanghai	China	121 28 e	31 10 n
Sofia	Bulgaria	23 20 e	42 40 n
Stockholm	Sweden	18 3 e	59 17 n
Sydney	Australia	151 0 e	34 0 s
Tananarive	Madagascar	47 33 e	18 50 s
Teheran	Iran	51 45 e	35 45 n
Tokyo	Japan	139 45 e	35 40 n
Tripoli	Libya	13 12 e	32 57 n
Venice	Italy	12 20 e	45 26 n
Veracruz	Mexico	96 10 w	19 10 n
Vienna	Austria	16 20 e	48 14 n
Warsaw	Poland	21 0 e	52 14 n
Wellington	New Zealand	174 47 e	41 17 s
Zürich	Switzerland	8 31 e	47 21 n

## INTERNATIONAL

Aberdeen	Scotland	2 9 w	57 9 n
Adelaide	Australia	138 36 e	34 55 s
Amsterdam	Holland	4 53 e	52 22 n
Ankara	Turkey	32 55 e	39 55 n
Asunción	Paraguay	57 40 w	25 15 s
Athens	Greece	23 43 e	37 58 n
Auckland	New Zealand	174 45 e	36 52 s
Bangkok	Thailand	100 30 e	13 45 n
Barcelona	Spain	2 9 e	41 23 n
Belém	Brazil	48 29 w	1 28 s
Belfast	Northern Ireland	5 56 w	54 37 n
Belgrade	Yugoslavia	20 32 e	44 52 n
Berlin	Germany	13 25 e	52 30 n
Birmingham	England	1 55 w	52 25 n
Bombay	India	72 48 e	19 0 n
Bordeaux	France	0 31 w	44 50 n
Bremen	Germany	8 49 e	53 5 n
Brisbane	Australia	153 8 e	27 29 s
Bristol	England	2 35 w	51 28 n
Brussels	Belgium	4 22 e	50 52 n
Bucharest	Romania	26 7 e	44 25 n
Budapest	Hungary	19 5 e	47 30 n
Buenos Aires	Argentina	58 22 w	34 35 s
Cairo	Egypt	31 21 e	30 2 n
Canton	China	113 15 e	23 7 n
Cape Town	South Africa	18 22 e	33 55 s
Caracas	Venezuela	67 2 w	10 28 n
Chihuahua	Mexico	106 5 w	28 37 n
Chongqing	China	106 34 e	29 46 n
Copenhagen	Denmark	12 34 e	55 40 n
Córdoba	Argentina	64 10 w	31 28 s
Darwin	Australia	130 51 e	12 28 s
Dublin	Ireland	6 15 w	53 20 n
Durban	South Africa	30 53 e	29 53 s
Edinburgh	Scotland	3 10 w	55 55 n
Frankfurt	Germany	8 41 e	50 7 n
Georgetown	Guyana	58 15 w	6 45 n

## Appendix D - RS-232 Connection

To make a RS-232 connection with the NexStar, the hand control must be in *RS-232 mode* – which can be accessed through the Menu button. Once in the RS-232 mode, the hand control still has the following abilities:

- **Direction buttons** – Allowing you to move the telescope in both directions
- **Rate changes** – Allows you to change the telescope's rate of speed when using the direction buttons.
- **Undo** – Use to escape from RS-232 mode.

### Protocol:

NexStar5 communicates at 9600 bits/sec, No parity and stop bit.. All angles are communicated with 16 bit numbers.

Before all commands, the following INITIALIZATION is necessary:

- PC sends one byte (63=Ascii “?”) to check that NexStar is ready.
- NexStar responds with one byte (35) when NexStar is ready to respond. After NexStar sends a 35, the buttons to the hand control **do not respond until the command from the PC has been received**, then the direction, rate, and undo buttons are active.

Goto RA-Dec positions:

- INITIALIZATION
- PC sends (82=Ascii “R”)
- PC sends the RA high byte, RA low byte, Dec high byte, Dec low byte.
- When the scope is finished slewing, it will send back a “@”.

Goto Alt-Az positions:

- INITIALIZATION
- PC sends (65=Ascii “A”)
- PC sends the Azm high byte, Azm low byte, Alt high byte, Alt low byte.
- When the scope is finished slewing, it will send back a “@”.

Get RA-Dec positions:

- INITIALIZATION
- PC sends (69=Ascii “E”)
- NexStar sends the RA high byte, RA low byte, Dec high byte, Dec low byte.

Get Alt-Az positions:

- INITIALIZATION
- PC sends (90=Ascii “Z”)
- NexStar sends the Azm high byte, Azm low byte, Alt high byte, Alt low byte.

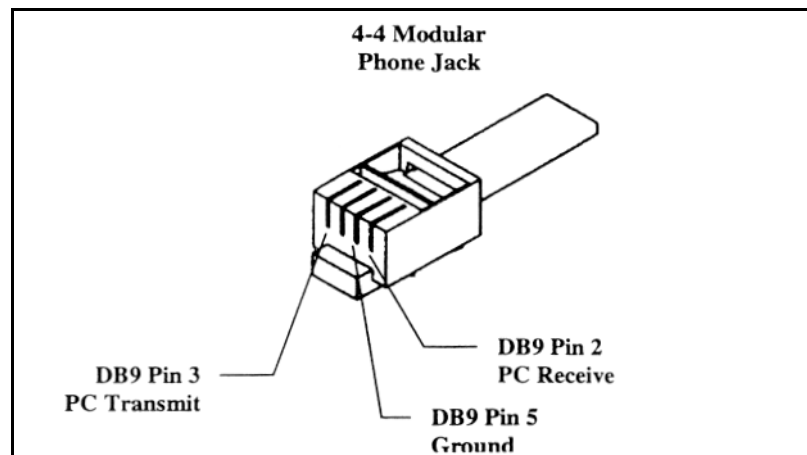

# Appendix E – Maps of the Time Zones

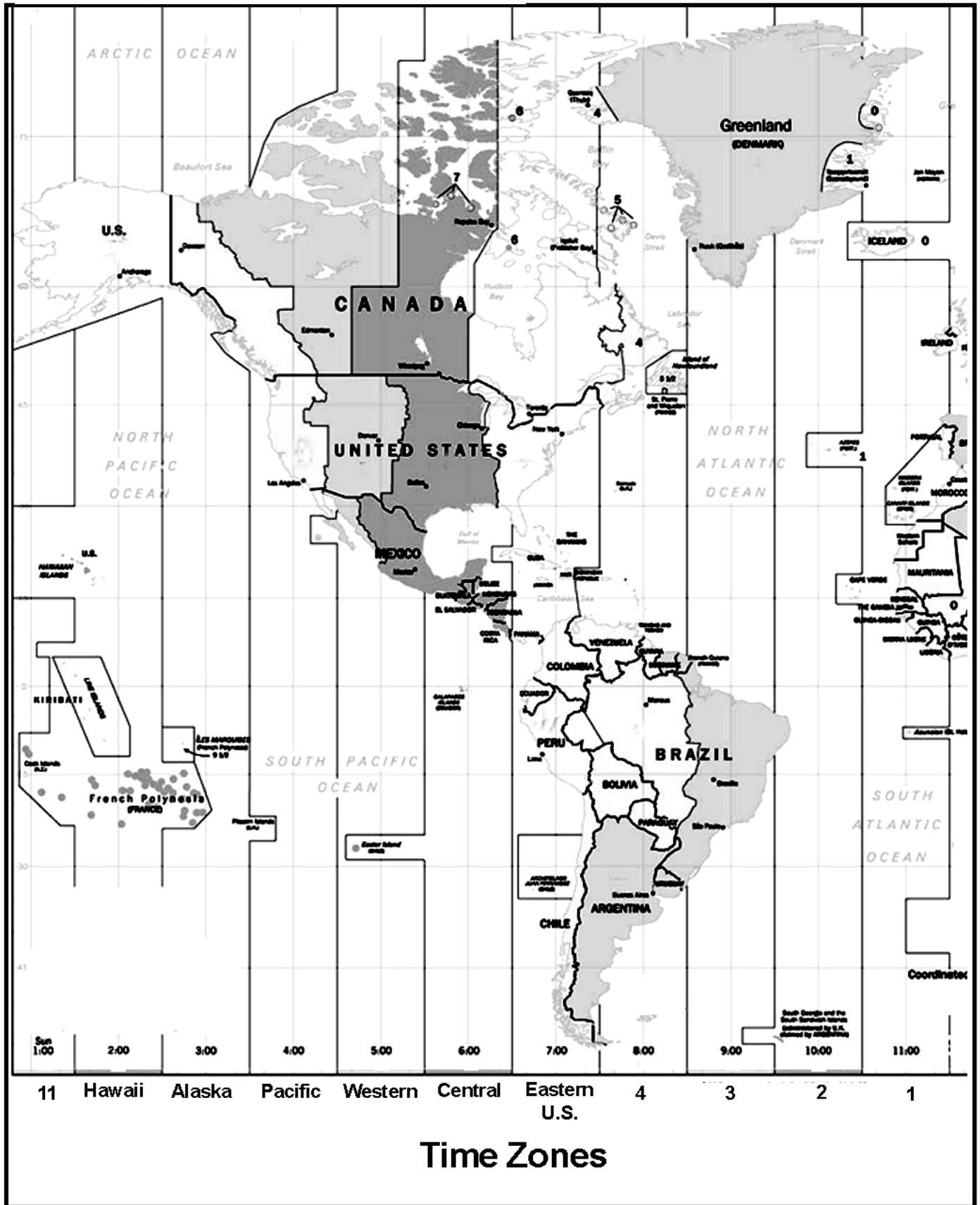

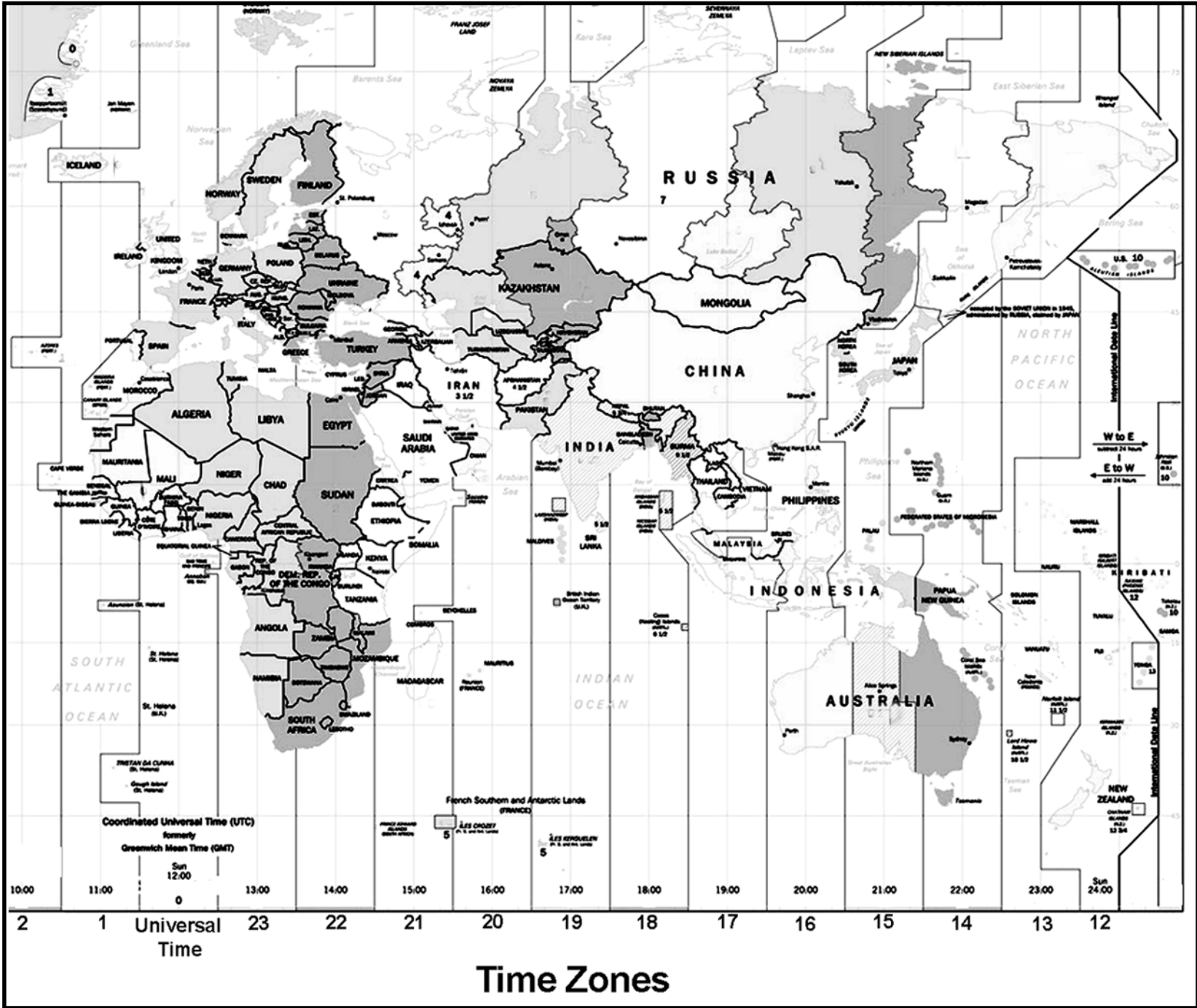

# January - February Sky

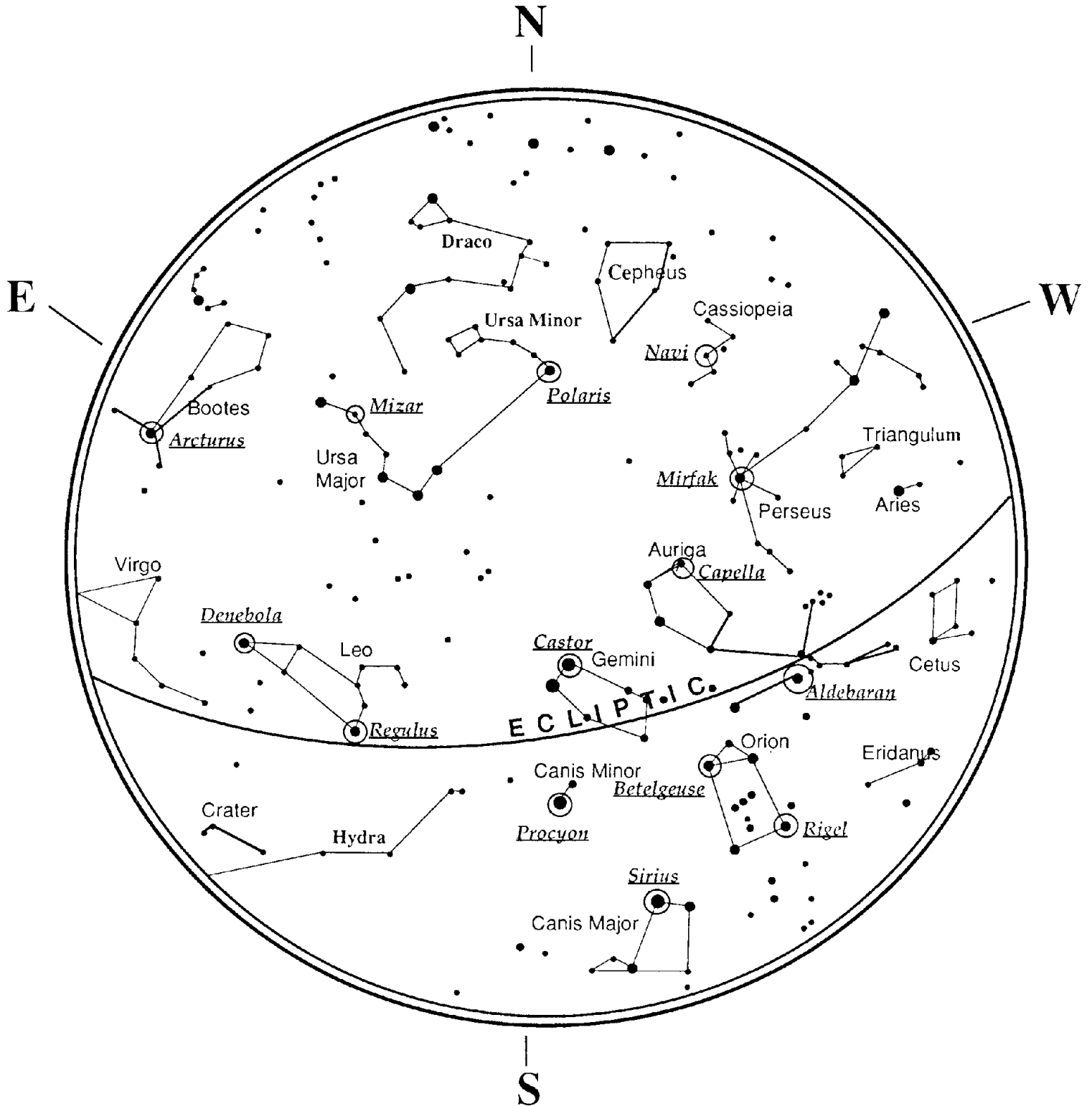

# March - April Sky

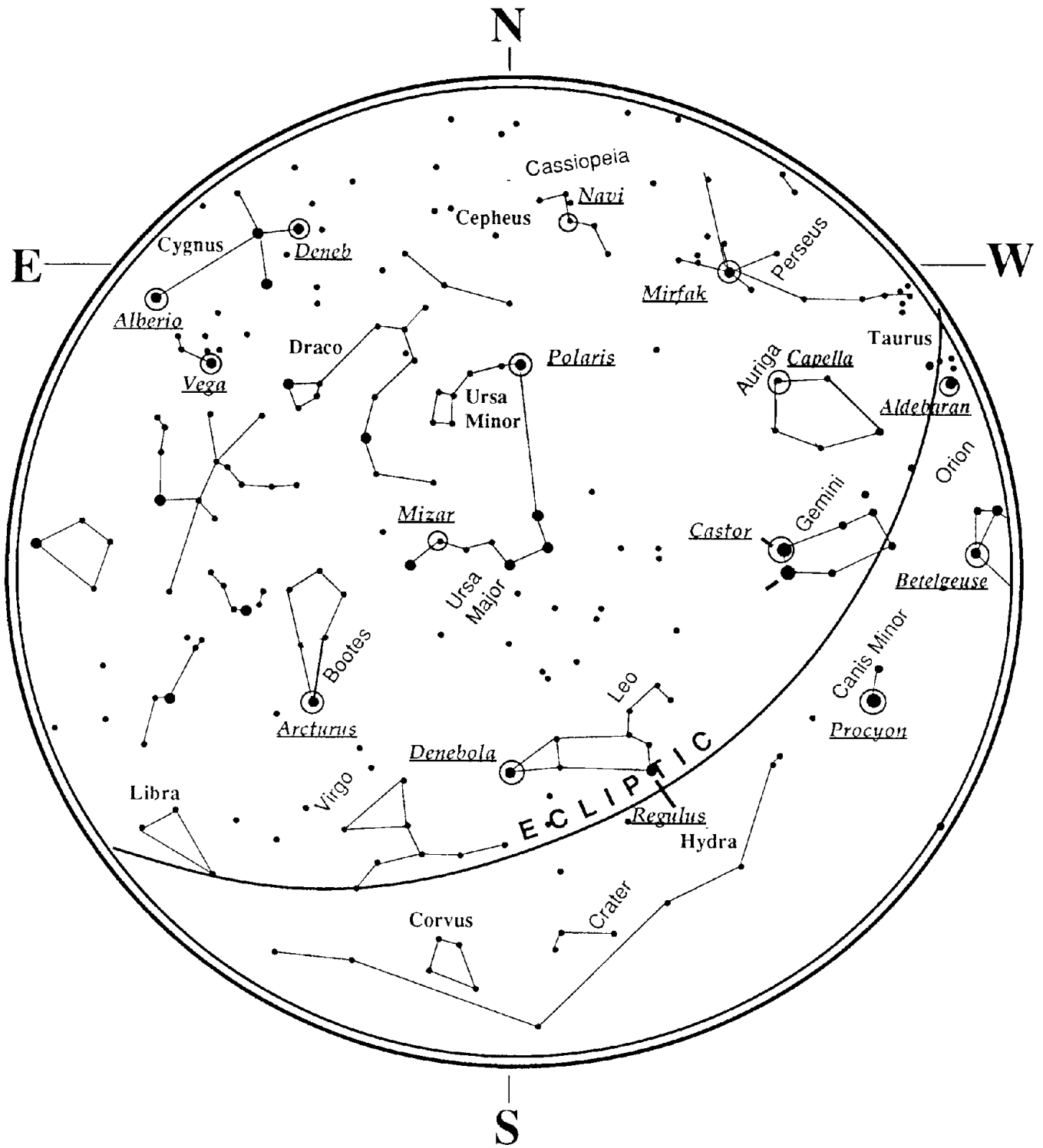

# May - June Sky

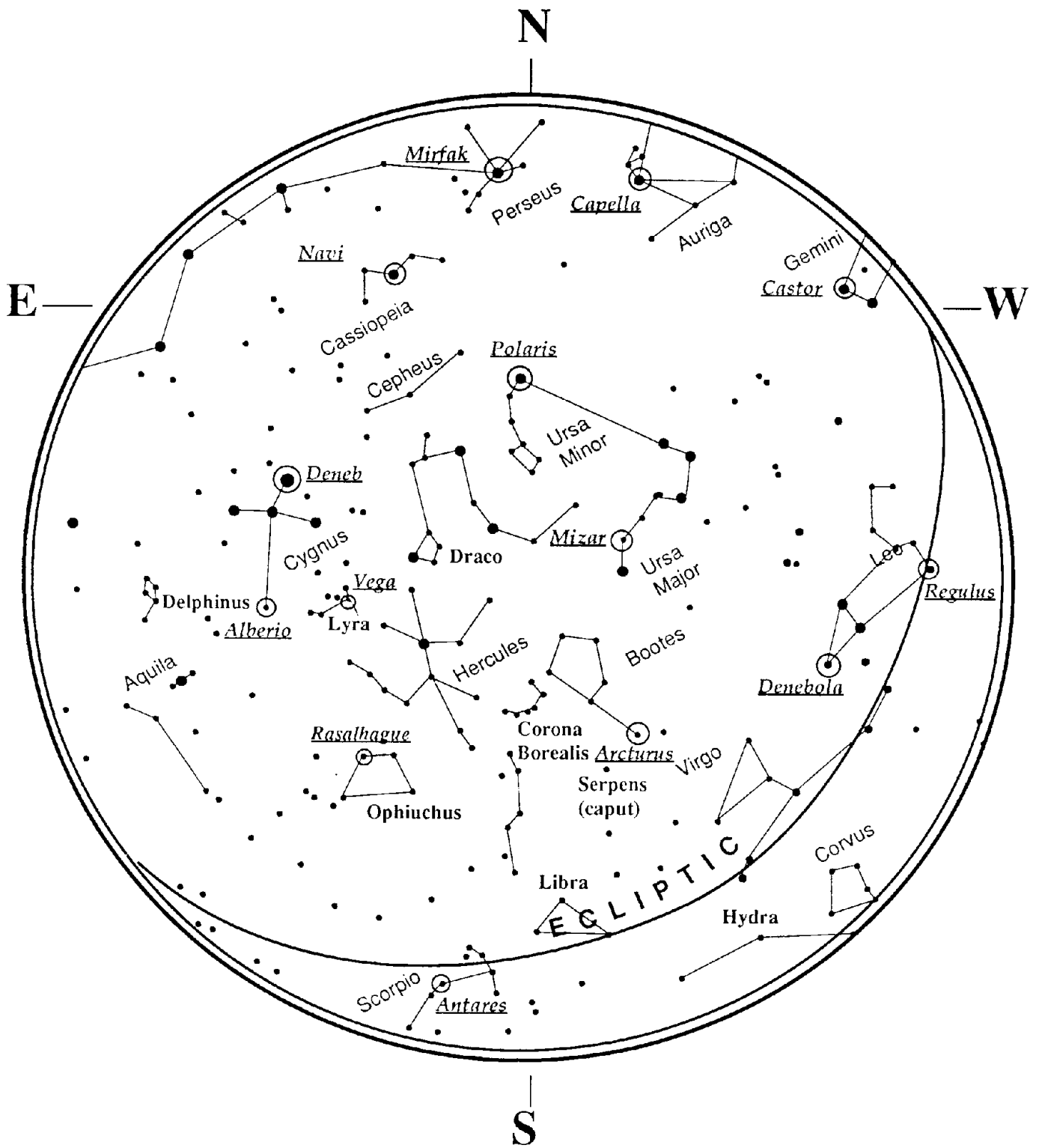



# July - August Sky

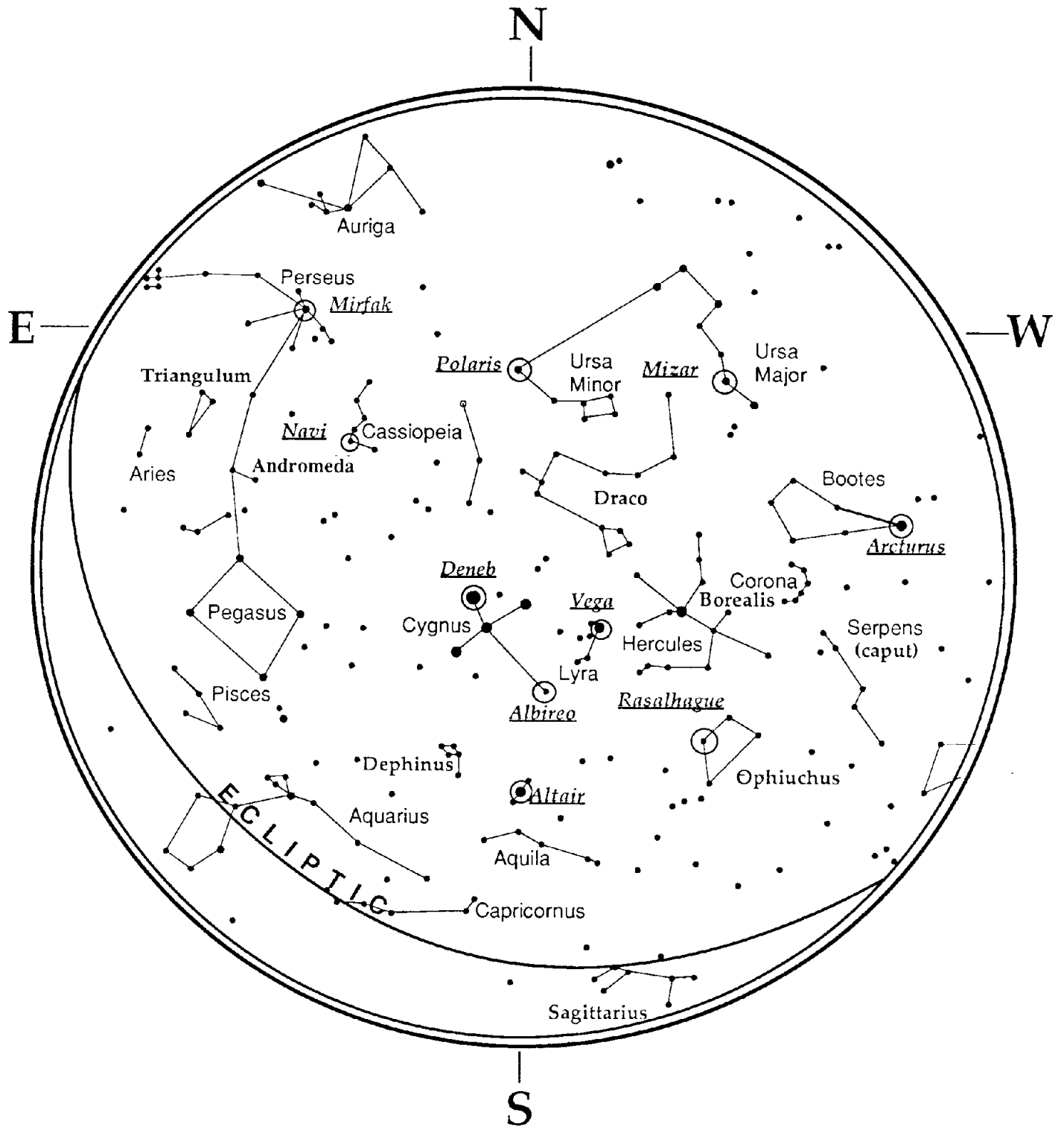

# September - October Sky

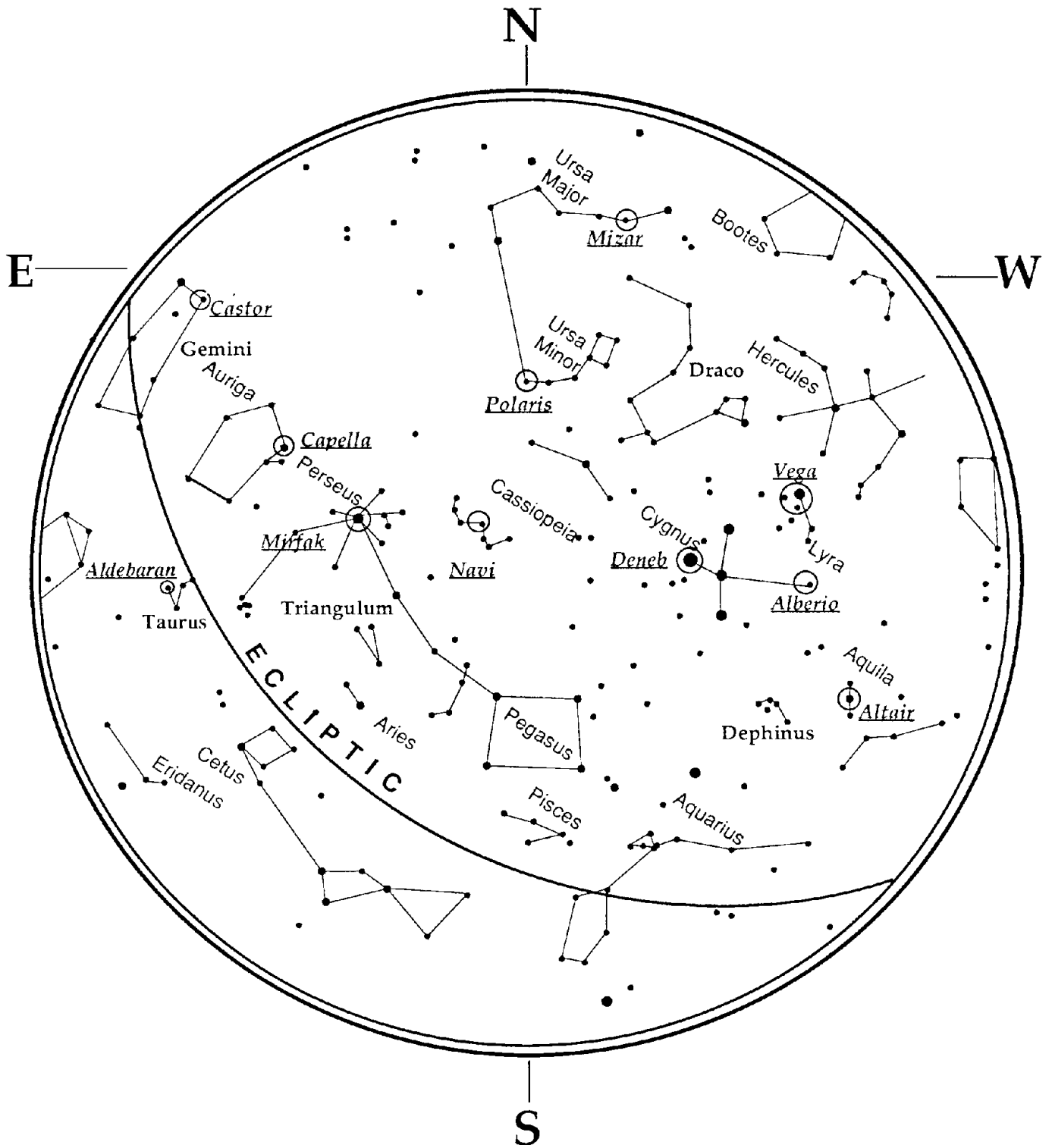

# November - December Sky

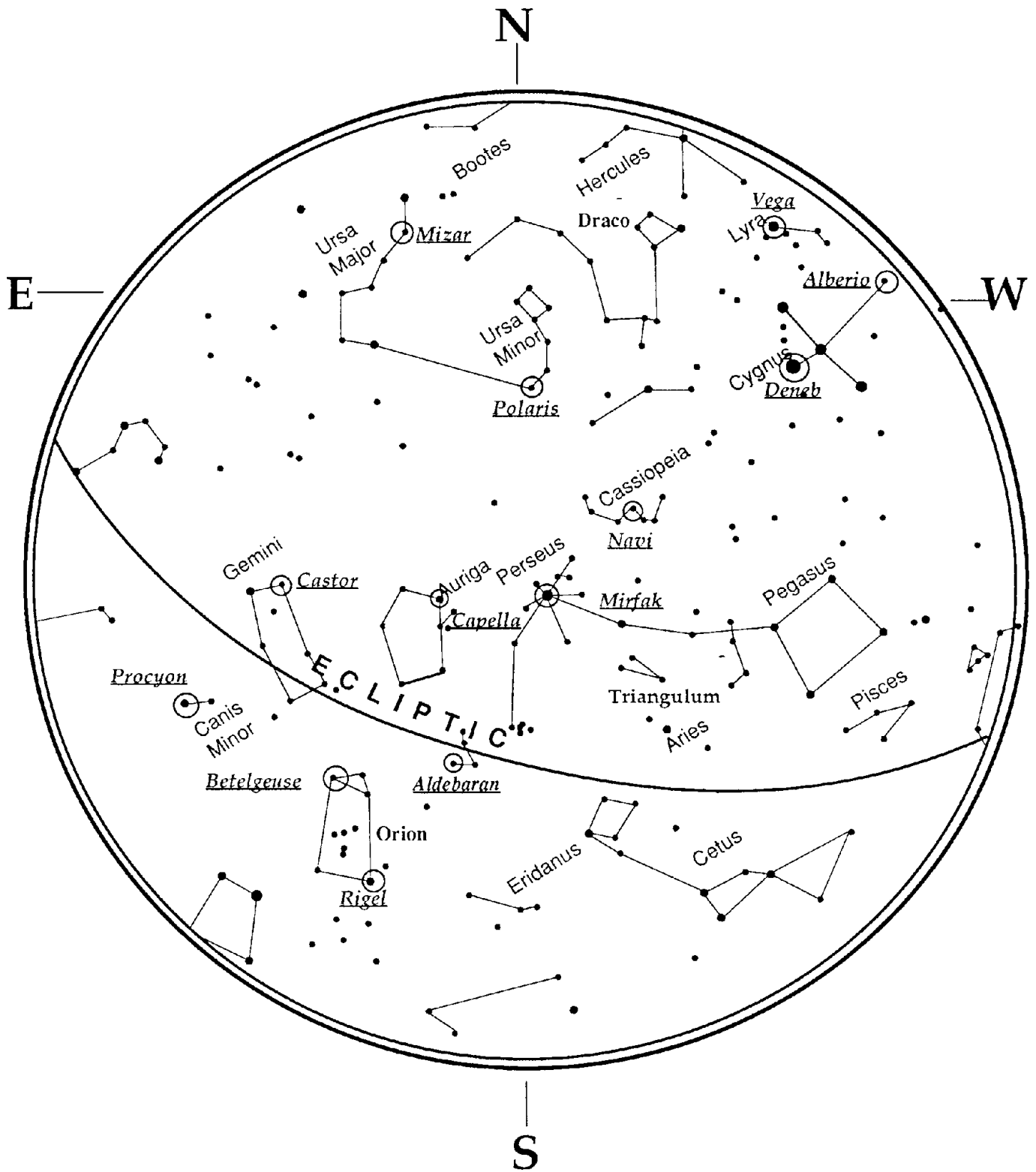

## CELESTRON ONE YEAR WARRANTY

- A. Celestron International (CI) warrants this telescope to be free from defects in materials and workmanship for one year. CI will repair or replace such product or part thereof which, upon inspection by CI, is found to be defective in materials or workmanship. As a condition to the obligation of CI to repair or replace such product, the product must be returned to CI together with proof-of-purchase satisfactory to CI.
- B. The Proper Return Authorization Number must be obtained from CI in advance of return. Call Celestron at (310) 328-9560 to receive the number to be displayed on the outside of your shipping container.

All returns must be accompanied by a written statement setting forth the name, address, and daytime telephone number of the owner, together with a brief description of any claimed defects. Parts or product for which replacement is made shall become the property of CI.

**The customer shall be responsible for all costs of transportation and insurance, both to and from the factory of CI, and shall be required to prepay such costs.**

CI shall use reasonable efforts to repair or replace any telescope covered by this warranty within thirty days of receipt. In the event repair or replacement shall require more than thirty days, CI shall notify the customer accordingly. CI reserves the right to replace any product which has been discontinued from its product line with a new product of comparable value and function.

**This warranty shall be void and of no force of effect in the event a covered product has been modified in design or function, or subjected to abuse, misuse, mishandling or unauthorized repair. Further, product malfunction or deterioration due to normal wear is not covered by this warranty.**

CI DISCLAIMS ANY WARRANTIES, EXPRESS OR IMPLIED, WHETHER OF MERCHANTABILITY OF FITNESS FOR A PARTICULAR USE, EXCEPT AS EXPRESSLY SET FORTH HEREIN.

THE SOLE OBLIGATION OF CI UNDER THIS LIMITED WARRANTY SHALL BE TO REPAIR OR REPLACE THE COVERED PRODUCT, IN ACCORDANCE WITH THE TERMS SET FORTH HEREIN. CI EXPRESSLY DISCLAIMS ANY LOST PROFITS, GENERAL, SPECIAL, INDIRECT OR CONSEQUENTIAL DAMAGES WHICH MAY RESULT FROM BREACH OF ANY WARRANTY, OR ARISING OUT OF THE USE OR INABILITY TO USE ANY CI PRODUCT. ANY WARRANTIES WHICH ARE IMPLIED AND WHICH CANNOT BE DISCLAIMED SHALL BE LIMITED IN DURATION TO A TERM OF ONE YEAR FROM THE DATE OF ORIGINAL RETAIL PURCHASE.

Some states do not allow the exclusion or limitation of incidental or consequential damages or limitation on how long an implied warranty lasts, so the above limitations and exclusions may not apply to you.

This warranty gives you specific legal rights, and you may also have other rights which vary from state to state.

CI reserves the right to modify or discontinue, without prior notice to you, any model or style telescope.

If warranty problems arise, or if you need assistance in using your telescope contact:

Celestron International  
Customer Service Department  
2835 Columbia Street  
Torrance, CA 90503  
Tel. (310) 328-9560  
Fax. (310) 212-5835  
Monday-Friday 8AM-4PM PST

This warranty supersedes all other product warranties.

**NOTE: This warranty is valid to U.S.A. and Canadian customers who have purchased this product from an Authorized CI Dealer in the U.S.A. or Canada. Warranty outside the U.S.A. and Canada is valid only to customers who purchased from a CI International Distributor or Authorized CI Dealer in the specific country and please contact them for any warranty service.**



Celestron International  
2835 Columbia Street  
Torrance, CA 90503  
Tel. (310) 328-9560  
Fax. (310) 212-5835  
Web site at <http://www.celestron.com>

Copyright 1999 Celestron International  
All rights reserved.

(Products or instructions may change  
without notice or obligation.)

Item # 11011-INST  
\$10.00  
03/00